

TFT COLOR LCD MODULE

NL10276BC12-02

16.1cm (6.3 Type)

XGA

LVDS interface (1port)

DATA SHEET

DOD-PD-0197 (4th edition)



**This DATA SHEET is updated document from
DOD-PD-0030 (3).**

**All information is subject to change without notice.
Please confirm the sales representative before
starting to design your system.**

INTRODUCTION

No part of this document shall be copied in any form or by any means without the prior written consent of NEC LCD Technologies, Ltd. (hereinafter called "NEC").

NEC does not assume any liability for infringement of patents, copyrights or other intellectual property rights of third parties by or arising from use of a product described herein or any other liability arising from use of such application. No license, express, implied or otherwise, is granted under any patents, copyrights or other intellectual property rights of NEC or of others.

While NEC has been making continuous effort to enhance the reliability of its products, the possibility of failures cannot be eliminated entirely. To minimize risks of damage to property or injury to person arising from a failure in an NEC product, customers must incorporate sufficient safety measures in their design, such as redundancy, fire-containment and anti-failure features.

NEC products are classified into the following three quality grades:

"Standard", "Special", "Specific"

The *"Specific"* quality grade applies only to applications developed based on a customer designated "quality assurance program" for a specific application. The recommended applications of a product depend on its quality grade, as indicated below. Customers must check the quality grade of each application before using it in a particular application.

Standard: Computers, office equipment, communications equipment, test and measurement equipment, audio and visual equipment, home electronic appliances, machine tools, personal electronic equipment and industrial robots

Special: Transportation equipment (automobiles, trains, ships, etc.), traffic control systems, anti-disaster systems, anti-crime systems, safety equipment and medical equipment (not specifically designed for life support)

Specific: Military systems, aircraft, aerospace equipment, submersible repeaters, nuclear reactor control systems, life support systems (medical equipment, etc.) and any other equipment

The quality grade of this product is *"Standard"* unless otherwise specified in this document. If customers intend to use this product for applications other than those specified for *"Standard"* quality grade, they should contact NEC sales representative in advance.

CONTENTS

INTRODUCTION2

1. OUTLINE.....5

 1.1 STRUCTURE AND PRINCIPLE.....5

 1.2 APPLICATIONS.....5

 1.3 FEATURES.....5

2. GENERAL SPECIFICATIONS6

3. BLOCK DIAGRAM.....7

4. DETAILED SPECIFICATIONS8

 4.1 MECHANICAL SPECIFICATIONS.....8

 4.2 ABSOLUTE MAXIMUM RATINGS8

 4.3 ELECTRICAL CHARACTERISTICS.....9

 4.3.1 Driving for LCD panel signal processing board.....9

 4.3.2 Working for backlight lamp10

 4.3.3 Power supply voltage ripple.....11

 4.3.4 Fuse.....11

 4.4 POWER SUPPLY VOLTAGE SEQUENCE12

 4.4.1 Sequence for LCD panel signal processing board12

 4.4.2 Sequence for backlight inverter (Option).....12

 4.5 CONNECTIONS AND FUNCTIONS FOR INTERFACE PINS.....13

 4.5.1 LCD panel signal processing board13

 4.5.2 Backlight lamp.....14

 4.5.3 Positions of plugs and a socket.....14

 4.5.4 Connection between receiver and transmitter for LVDS15

 4.6 DISPLAY COLORS AND INPUT DATA SIGNALS16

 4.6.1 Combinations between input data signals and FRC signal16

 4.6.2 16,194,277 colors.....17

 4.6.3 262,144 colors.....18

 4.7 DISPLAY POSITIONS.....19

 4.8 SCANNING DIRECTIONS19

 4.9 INPUT SIGNAL TIMINGS FOR LCD PANEL SIGNAL PROCESSING BOARD20

 4.9.1 Outline of input signal timings20

 4.9.2 Timing characteristics21

 4.9.3 Input signal timing chart.....22

 4.10 OPTICS.....23

 4.10.1 Optical characteristics.....23

 4.10.2 Definition of contrast ratio.....24

 4.10.3 Definition of luminance uniformity24

 4.10.4 Definition of response times24

 4.10.5 Definition of viewing angles.....24

CONTENTS

5. RELIABILITY TESTS.....25

6. PRECAUTIONS26

6.1 MEANING OF CAUTION SIGNS26

6.2 CAUTIONS26

6.3 ATTENTIONS26

6.3.1 Handling of the product26

6.3.2 Environment.....27

6.3.3 Characteristics.....27

6.3.4 Other27

7. OUTLINE DRAWINGS28

7.1 FRONT VIEW28

7.2 REAR VIEW29

1. OUTLINE

1.1 STRUCTURE AND PRINCIPLE

NL10276BC12-02 module is composed of the amorphous silicon thin film transistor liquid crystal display (a-Si TFT LCD) panel structure with driver LSIs for driving the TFT (Thin Film Transistor) array and a backlight.

The a-Si TFT LCD panel structure is injected liquid crystal material into a narrow gap between the TFT array glass substrate and a color-filter glass substrate.

Color (Red, Green, Blue) data signals from a host system (e.g. PC, signal generator, etc.) are modulated into best form for active matrix system by a signal processing board, and sent to the driver LSIs which drive the individual TFT arrays.

The TFT array as an electro-optical switch regulates the amount of transmitted light from the backlight assembly, when it is controlled by data signals. Color images are created by regulating the amount of transmitted light through the TFT array of red, green and blue dots.

1.2 APPLICATIONS

- Display terminal for control system

1.3 FEATURES

- High resolution
- High luminance
- High contrast
- Low reflection
- Wide temperature range
- LVDS interface
- Reversible-scan direction
- Selectable 8bit or 6bit digital signals for data of RGB
- Edge light type
- Replaceable lamp for backlight (Inverter less)
- Acquisition product for UL1950 3rd edition/CSA C22.2 No.950-95 (File number: E170632)

2. GENERAL SPECIFICATIONS

Display area	129.02 (W) × 96.77 (H) mm (typ.)
Diagonal size of display	16.1 cm (6.3 inches)
Drive system	a-Si TFT active matrix
Display color	At input signals for data of RGB: 8bit and FRC: High 16,194,277 colors
Pixel	1024 (H) × 768 (V) pixels
Pixel arrangement	RGB (Red dot, Green dot, Blue dot) vertical stripe
Dot pitch	0.042 (W) × 0.126 (H) mm
Pixel pitch	0.126 (W) × 0.126 (H) mm
Module size	178.8 (W) × 126.8 (H) × 12.0 (D) mm (typ.)
Weight	265 g (typ.)
Contrast ratio	500:1 (typ.)
Viewing angle	At the contrast ratio 10:1 <ul style="list-style-type: none"> • Horizontal: Right side 60° (typ.), Left side 60° (typ.) • Vertical: Up side 45° (typ.), Down side 60° (typ.)
Designed viewing direction	At DPSR= Low or open: normal scan <ul style="list-style-type: none"> • Viewing direction without image reversal: up side (12 o'clock) • Viewing direction with contrast peak: down side (6 o'clock) • Viewing angle with optimum grayscale ($\gamma=2.2$): normal axis
Polarizer surface	Antiglare treatment
Polarizer pencil-hardness	3H (min.) [by JIS K5400]
Color gamut	At LCD panel center 40 % (typ.) [against NTSC color space]
Response time	Ton (white 90%→black 10%) 6 ms (typ.)
Luminance	At 5.0mArms / lamp 250 cd/m ² (typ.)
Signal system	LVDS 1port (Receiver: THC63LVDF84A, Thine Electronics Inc. or equivalent) 8bit/6bit digital signals for data of RGB colors, Dot clock (CLK), Data enable (DE)
Power supply voltage	LCD panel signal processing board: 3.3V
Backlight	Edge light type: 2 cold cathode fluorescent lamps <div style="display: flex; align-items: center;"> <div style="font-size: 2em; margin-right: 5px;">{</div> <div style="margin-right: 5px;">Replaceable parts</div> <div style="margin-right: 5px;">• Lamp holder set: Type No. 63LHS01</div> <div style="font-size: 2em; margin-left: 5px;">}</div> </div> <div style="display: flex; align-items: center;"> <div style="font-size: 2em; margin-right: 5px;">{</div> <div style="margin-right: 5px;">Recommended inverter (Option)</div> <div style="margin-right: 5px;">• Inverter: Type No. 65PWB31</div> <div style="font-size: 2em; margin-left: 5px;">}</div> </div>
Power consumption	At 5.0mArms / lamp and checkered flag pattern 4.9 W (typ.)

3. BLOCK DIAGRAM

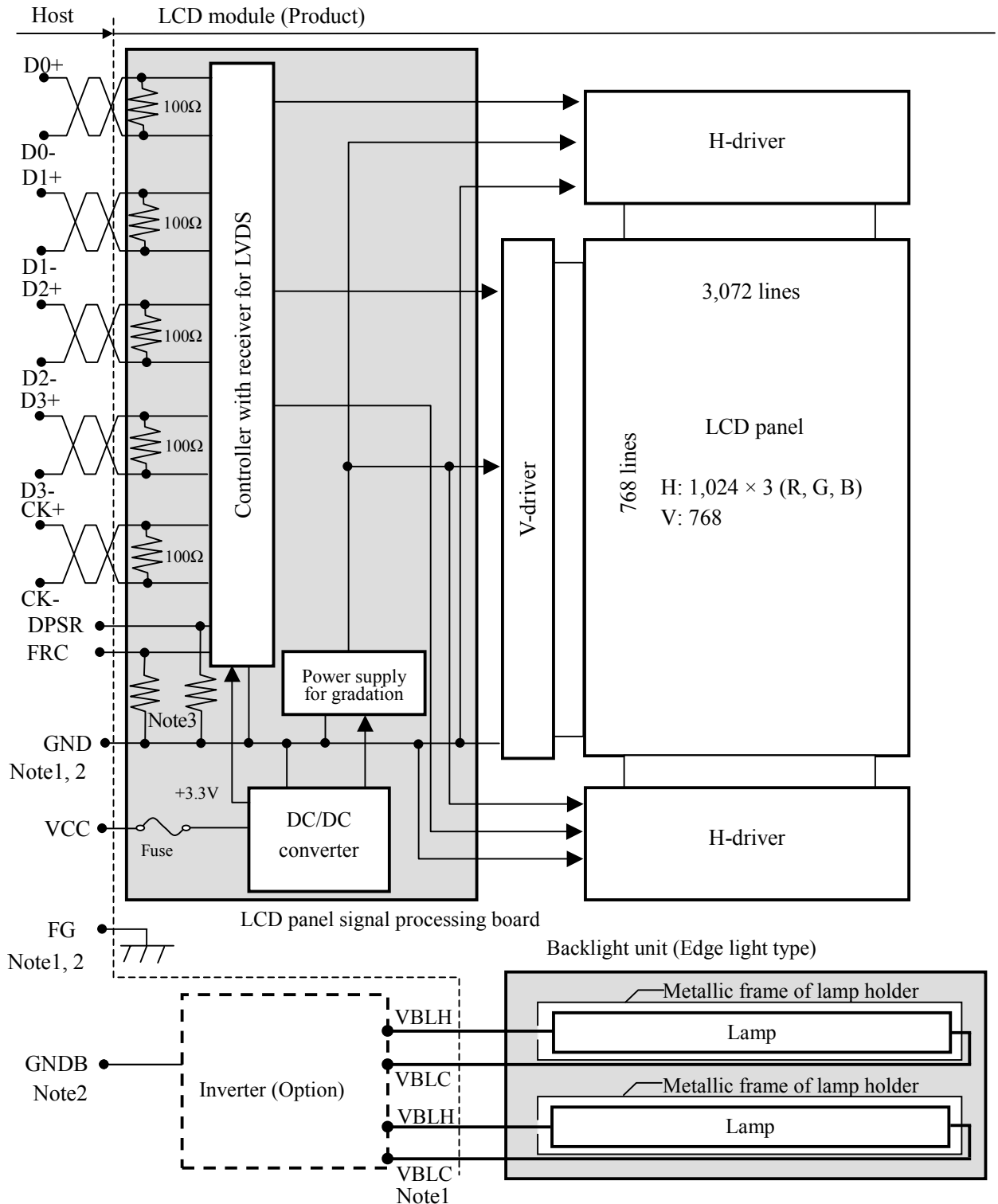

Note1: Connections between GND (Signal ground), FG (Frame ground) and VBLC (Lamp low voltage terminal) in the LCD module

GND - FG	Not connected
GND - VBLC	Not connected
FG - VBLC	Not connected

Note2: GND, FG and GNDB must be connected to customer equipment's ground, and it is recommended that these grounds are connected together in customer equipment.

Note3: Pull-down resistance of DPSR and FRC

☆

DPSR pin		(kΩ)
min.	typ.	max.
6.6	8.3	9.2

FRC pin		(kΩ)
min.	typ.	max.
20	50	132

4. DETAILED SPECIFICATIONS

4.1 MECHANICAL SPECIFICATIONS

Parameter	Specification	Unit
Module size	178.8 ± 0.5 (W) × 126.8 ± 0.5 (H) × 12.0 ± 0.5 (D) Note1	mm
Display area	129.02 (W) × 96.77 (H) Note1	mm
Weight	265 (typ.), 295 (max.)	g

Note1: See "7. OUTLINE DRAWINGS".

4.2 ABSOLUTE MAXIMUM RATINGS

Parameter		Symbol	Rating	Unit	Remarks
Power supply voltage	LCD panel signal processing board	VCC	-0.3 to +4.0	V	Ta = 25°C
	Lamp voltage	VBLH	1,500	Vrms	
Input voltage for signals	Display signals Note1	VD	-0.3 to VCC+0.3	V	
	Function signals Note2	VF	-0.3 to VCC+0.3	V	
Storage temperature		Tst	-20 to +80	°C	-
Operating temperature	Front surface	TopF	0 to +65	°C	Note3
	Rear surface	TopR	0 to +70	°C	Note4
Relative humidity Note5		RH	≤ 95	%	Ta ≤ 40°C
			≤ 85	%	40 < Ta ≤ 50°C
Absolute humidity Note5		AH	≤ 70 Note6	g/m ³	Ta > 50°C

Note1: Display signals are D0+/-, D1+/-, D2+/-, D3+/- and CK+/-.

Note2: Function signals are DPSR and FRC.

Note3: Measured at center of LCD panel surface (including self-heat)

Note4: Measured at center of LCD module's rear shield surface (including self-heat)

Note5: No condensation

Note6: Ta = 50°C, RH = 85%

4.3 ELECTRICAL CHARACTERISTICS

4.3.1 Driving for LCD panel signal processing board

(Ta = 25°C)

Parameter	Symbol	Min.	Typ.	Max.	Unit	Remarks
Power supply voltage	VCC	3.0	3.3	3.6	V	-
Power supply current	ICC	-	275 Note1	600 Note2	mA	at VCC = 3.3V
Permissible ripple voltage	VRP	-	-	100	mV	for VCC
Differential input threshold voltage for LVDS receiver	Low	VTL	-100	-	mV	at VCM=1.2V Note3
	High	VTH	-	-	+100	
Terminating resistor	RT	-	100	-	Ω	-
Input voltage for DPSR and FRC signals	Low	VFL	0	-	0.8	LVTTTL level
	High	VFH	2.0	-	VCC	

Note1: Checkered flag pattern [by EIAJ ED-2522]

Note2: Pattern for maximum current

Note3: Common mode voltage for LVDS receiver

4.3.2 Working for backlight lamp

(Ta=25°C Note1)

Parameter	Symbol	Min.	Typ.	Max.	Unit	Remarks
Lamp current	IBL	2.0	5.0	5.5	mArms	at IBL=5.0mArms: 250cd/m ² Note3
Lamp voltage	VBLH	-	400	-	Vrms	Note2, Note3
Lamp starting voltage	VS	590	-	-	Vrms	Ta = 25°C Note2, Note3
		720	-	-	Vrms	Ta = 0°C Note2, Note3
Oscillation frequency	FO	50	54	58	kHz	Note4

Note1: This product's backlight consists of 2 lamps, and these specifications are for each lamp.

Note2: The lamp voltage cycle between lamps should be kept on a same phase. "VS" and "VBLH" are the voltage value between low voltage side (Cold) and high voltage side (Hot).

Note3: The asymmetric ratio of working waveform for lamps (Power supply voltage peak ratio, power supply current peak ratio and waveform space ratio) should be less than 5 % (See the following figure.). If the waveform is asymmetric, DC (Direct current) element apply into the lamp. In this case, a lamp lifetime may be shortened, because a distribution of a lamp enclosure substance inclines toward one side between low voltage terminal (Cold terminal) and high voltage terminal (Hot terminal).

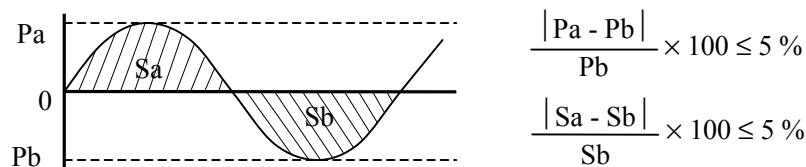

Pa: Supply voltage/current peak for positive, Pb: Supply voltage/current peak for negative
Sa: Waveform space for positive part, Sb: Waveform space for negative part

Note4: In case "FO" is not the recommended value, beat noise may display on the screen, because of interference between "FO" and "1/th". Recommended value of "FO" is as following.

$$FO = \frac{1}{4} \times \frac{1}{th} \times (2n-1)$$

th: Horizontal cycle (See "4.9.2 Timing characteristics".)

n: Natural number (1, 2, 3)

Note5: Method of lamp cable installation may invite fluctuation of lamp current and voltage or asymmetric of lamp working waveform. When design the backlight inverter, evaluate the fluctuation of lamp current and voltage or asymmetric of lamp working waveform sufficiently.

4.3.3 Power supply voltage ripple

This product works, even if the ripple voltage levels are beyond the permissible values as following the table, but there might be noise on the display image.

Parameter	Power supply voltage	Ripple voltage (Measure at input terminal of power supply)	Note1	Unit
VCC	3.3 V	≤ 100		mVp-p

Note1: The permissible ripple voltage includes spike noise.

4.3.4 Fuse

Parameter	Fuse		Rating	Fusing current	Remarks
	Type	Supplier			
VCC	KAB2402202NA31	Matsuo Electric Co., Ltd.	2.0 A	4.0 A	Note1
			24 V		

Note1: The power supply capacity should be more than the fusing current. If the power supply capacity is less than the fusing current, the fuse may not blow for a short time, and then nasty smell, smoking and so on may occur.

4.4 POWER SUPPLY VOLTAGE SEQUENCE

4.4.1 Sequence for LCD panel signal processing board

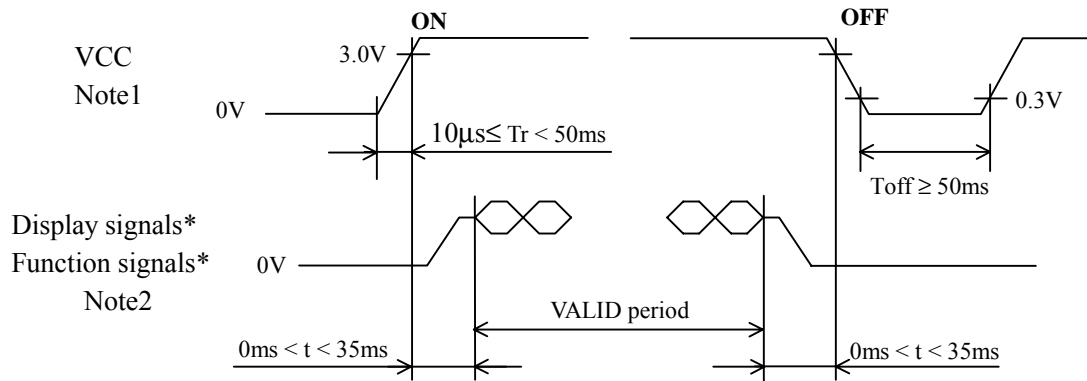

* These signals should be measured at the terminal of 100Ω resistor.

Note1: In terms of voltage variation (voltage drop) while VCC rising edge is below 3.0V, a protection circuit may work, and then this product may not work.

Note2: Display signals (D0+/-, D1+/-, D2+/-, D3+/- and CK+/-) and function signals (DPSR and FRC) signals must be Low or High-impedance, exclude the VALID period (See above sequence diagram), in order to avoid that internal circuits is damaged.

If some of display and function signals of this product are cut while this product is working, even if the signal input to it once again, it might not work normally. If customer stops the display and function signals, they should be cut VCC.

4.4.2 Sequence for backlight inverter (Option)

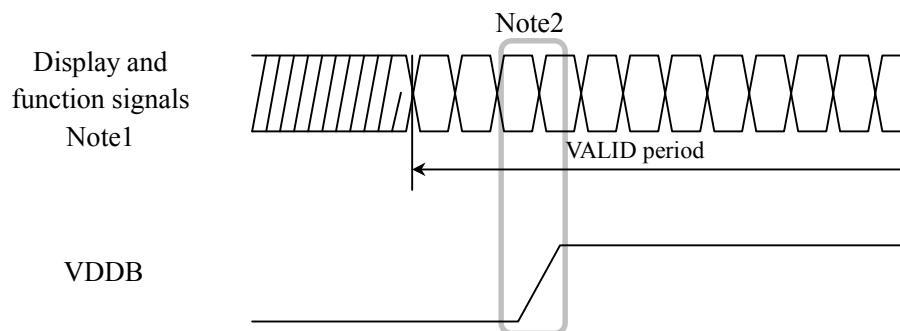

Note1: These are the display and function signals for LCD panel signal processing board.

Note2: The backlight inverter voltage (VDDB) should be inputted within the valid period of display and function signals, in order to avoid unstable data display.

4.5 CONNECTIONS AND FUNCTIONS FOR INTERFACE PINS

4.5.1 LCD panel signal processing board

CN1 socket (LCD module side): FI-SE20P-HF (Japan Aviation Electronics Industry Limited (JAE))
 Adaptable plug: FI-S20S (Japan Aviation Electronics Industry Limited (JAE))

Pin No.	Symbol	Signal	Remarks
1	A	D3+	Pixel data Ground Pixel data Ground Note1
	B	GND	
2	A	D3-	
	B	GND	
3	DPSR	Selection of scan direction	High: Reverse scan Low or Open: Normal scan Note2
4	FRC	Selection signal of frame rate control	High: Frame rate control ON Low or Open: Frame rate control OFF Note1
5	GND	Ground	-
6	CK+	Pixel clock	Note3
7	CK-		
8	GND	Ground	-
9	D2+	Pixel data	Note3
10	D2-		
11	GND	Ground	-
12	D1+	Pixel data	Note3
13	D1-		
14	GND	Ground	-
15	D0+	Pixel data	Note3
16	D0-		
17	GND	Ground	-
18	GND		
19	VCC	Power supply	-
20	VCC		

Note1: See "4.6 DISPLAY COLORS AND INPUT DATA SIGNALS".

Note2: See "4.8 SCANNING DIRECTIONS".

Note3: Twist pair wires with 100Ω (Characteristic impedance) should be connected between LCD panel signal processing board and LVDS transmitter.

4.5.2 Backlight lamp

Attention: VBLH and VBLC must be connected correctly. If customer connects wrongly, customer will be hurt and the module will be broken.

CN2 plug (LCD module side): BHR-03VS-1 (J.S.T Mfg. Co., Ltd.)

Adaptable socket: SM03 (4.0) B-BHS-1-TB (J.S.T Mfg. Co., Ltd.)

Pin No.	Symbol	Signal	Remarks
1	VBLH	High voltage (Hot)	Cable color: White
2	N.C.	Non connection	-
3	VBLC	Low voltage (Cold)	Cable color: Gray

CN3 plug (LCD module side): BHR-03VS-1 (J.S.T Mfg. Co., Ltd.)

Adaptable socket: SM03 (4.0) B-BHS-1-TB (J.S.T Mfg. Co., Ltd.)

Pin No.	Symbol	Signal	Remarks
1	VBLH	High voltage (Hot)	Cable color: White
2	N.C.	Non connection	-
3	VBLC	Low voltage (Cold)	Cable color: Gray

4.5.3 Positions of plugs and a socket

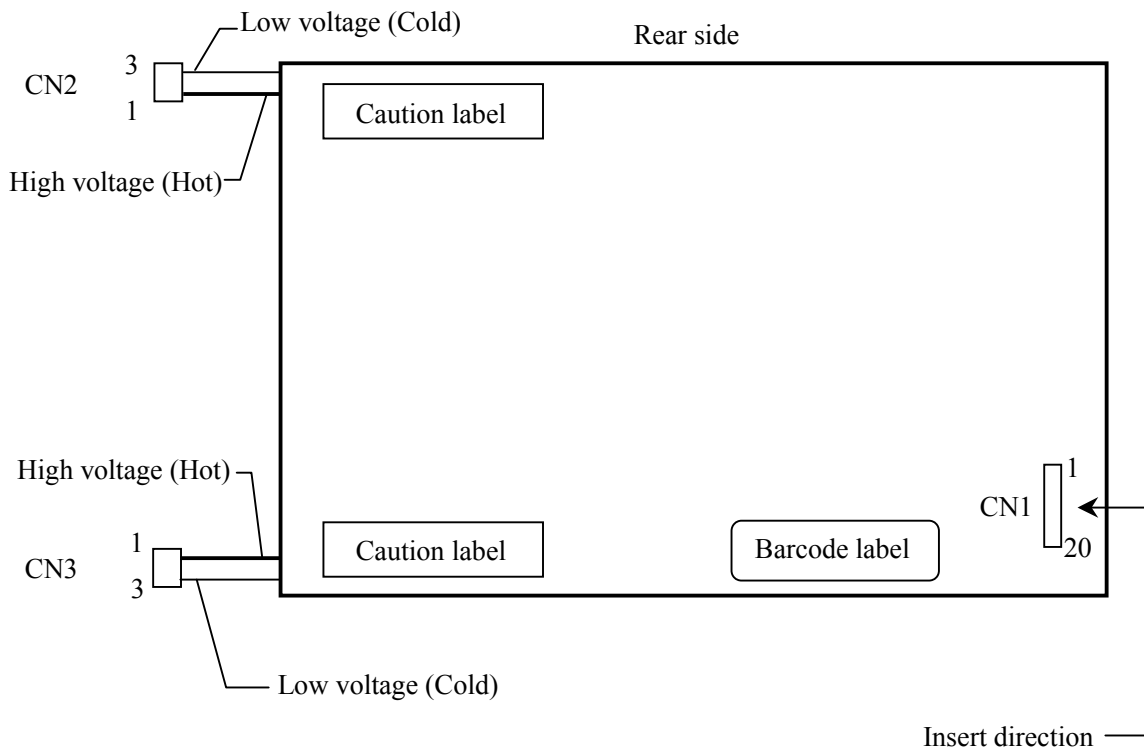

4.5.4 Connection between receiver and transmitter for LVDS

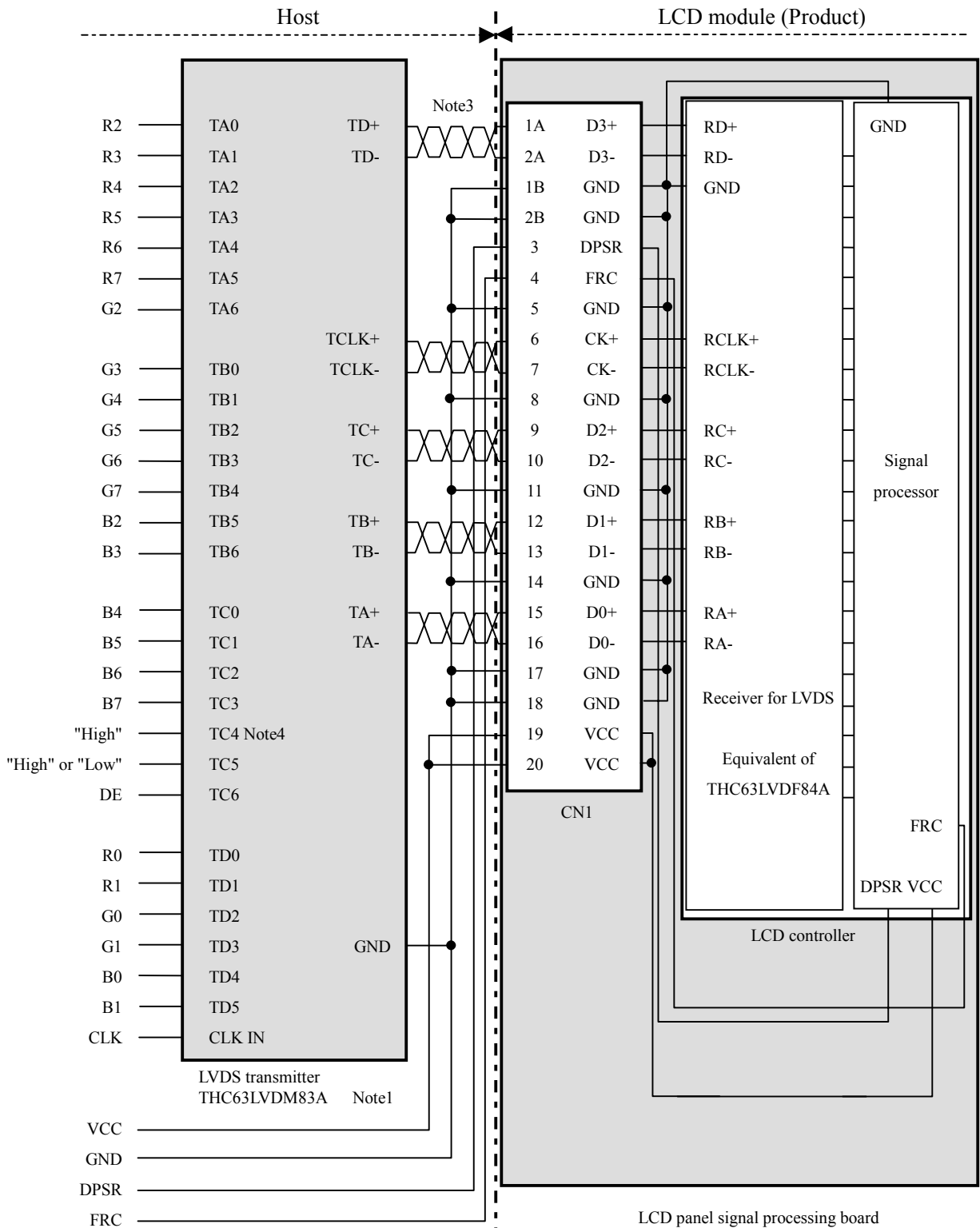

Note1: Recommended transmitter THC63LVDM83A (Thine Electronics Inc.).

Note2: LSB (Least Significant Bit) – R0, G0, B0 MSB (Most Significant Bit) – R7, G7, B7

Note3: Twist pair wires with 100Ω (Characteristic impedance) should be connected between LCD panel signal processing board and LVDS transmitter.

Note4: TC4 should be fixed to "High".

4.6 DISPLAY COLORS AND INPUT DATA SIGNALS

4.6.1 Combinations between input data signals and FRC signal

This product can display in equivalent to 16,194,277 in 253 scale and 262,144 colors in 64 scale by combination between input data signals and FRC signal. See following table.

Combination	Input data signals	CN1-Pin No.1 and 2	FRC signal	Display colors	Remarks
①	8bit	D3+/-	High	16,194,277	Note1
②	8bit	D3+/-	Low or Open	262,144	Note2
③	6bit	GND	Low or Open	262,144	

Note1: See "**4.6.2 16,194,277 colors**".

Note2: See "**4.6.3 262,144 colors**".

4.6.2 16,194,277 colors

This product can display in equivalent to 16,194,277 colors in 253 scale by combination ①. (See "4.6.1 Combinations between input data signals and FRC signal".)

Also the relation between display colors and input data signals is as the following table.

Display colors		Data signal (0: Low level, 1: High level)																							
		R7	R6	R5	R4	R3	R2	R1	R0	G7	G6	G5	G4	G3	G2	G1	G0	B7	B6	B5	B4	B3	B2	B1	B0
Basic Colors	Black	0	0	0	0	0	0	0	0	0	0	0	0	0	0	0	0	0	0	0	0	0	0	0	0
	Blue	0	0	0	0	0	0	0	0	0	0	0	0	0	0	0	0	1	1	1	1	1	1	α	α
	Red	1	1	1	1	1	1	α	α	0	0	0	0	0	0	0	0	0	0	0	0	0	0	0	0
	Magenta	1	1	1	1	1	1	α	α	0	0	0	0	0	0	0	0	1	1	1	1	1	1	α	α
	Green	0	0	0	0	0	0	0	0	1	1	1	1	1	1	α	α	0	0	0	0	0	0	0	0
	Cyan	0	0	0	0	0	0	0	0	1	1	1	1	1	1	α	α	1	1	1	1	1	1	α	α
	Yellow	1	1	1	1	1	1	α	α	1	1	1	1	1	1	α	α	0	0	0	0	0	0	0	0
	White	1	1	1	1	1	1	α	α	1	1	1	1	1	1	α	α	1	1	1	1	1	1	α	α
Red grayscale	Black	0	0	0	0	0	0	0	0	0	0	0	0	0	0	0	0	0	0	0	0	0	0	0	0
	dark	0	0	0	0	0	0	0	1	0	0	0	0	0	0	0	0	0	0	0	0	0	0	0	0
	↑																								
	↓																								
	bright	1	1	1	1	1	0	1	0	0	0	0	0	0	0	0	0	0	0	0	0	0	0	0	0
Red	1	1	1	1	1	0	1	1	0	0	0	0	0	0	0	0	0	0	0	0	0	0	0	0	
Green grayscale	Black	0	0	0	0	0	0	0	0	0	0	0	0	0	0	0	0	0	0	0	0	0	0	0	0
	dark	0	0	0	0	0	0	0	0	0	0	0	0	0	0	0	1	0	0	0	0	0	0	0	0
	↑																								
	↓																								
	bright	0	0	0	0	0	0	0	0	1	1	1	1	1	0	1	0	0	0	0	0	0	0	0	0
Green	0	0	0	0	0	0	0	0	1	1	1	1	1	1	α	α	0	0	0	0	0	0	0	0	
Blue grayscale	Black	0	0	0	0	0	0	0	0	0	0	0	0	0	0	0	0	0	0	0	0	0	0	0	0
	dark	0	0	0	0	0	0	0	0	0	0	0	0	0	0	0	0	0	0	0	0	0	0	0	1
	↑																								
	↓																								
	bright	0	0	0	0	0	0	0	0	0	0	0	0	0	0	0	0	1	1	1	1	1	0	1	0
Blue	0	0	0	0	0	0	0	0	0	0	0	0	0	0	0	0	1	1	1	1	1	1	α	α	

Note1: The input data signals "111111αα" is "11111100", "11111101", "11111110" and "11111111".
 These data signals become same grayscale.

4.6.3 262,144 colors

This product can display in equivalent to 262,144 colors in 64 scale by combination ② and ③. (See "4.6.1 Combinations between input data signals and FRC signal".)

Also the relation between display colors and input data signals is as the following table.

Display colors		Data signal (0: Low level, 1: High level)																	
		R 5	R 4	R 3	R 2	R 1	R 0	G 5	G 4	G 3	G 2	G 1	G 0	B 5	B 4	B 3	B 2	B 1	B 0
Basic colors	Black	0	0	0	0	0	0	0	0	0	0	0	0	0	0	0	0	0	0
	Blue	0	0	0	0	0	0	0	0	0	0	0	0	1	1	1	1	1	1
	Red	1	1	1	1	1	1	0	0	0	0	0	0	0	0	0	0	0	0
	Magenta	1	1	1	1	1	1	0	0	0	0	0	0	1	1	1	1	1	1
	Green	0	0	0	0	0	0	1	1	1	1	1	1	0	0	0	0	0	0
	Cyan	0	0	0	0	0	0	1	1	1	1	1	1	1	1	1	1	1	1
	Yellow	1	1	1	1	1	1	1	1	1	1	1	1	0	0	0	0	0	0
	White	1	1	1	1	1	1	1	1	1	1	1	1	1	1	1	1	1	1
Red scale	Black	0	0	0	0	0	0	0	0	0	0	0	0	0	0	0	0	0	0
		0	0	0	0	0	1	0	0	0	0	0	0	0	0	0	0	0	0
	dark	0	0	0	0	1	0	0	0	0	0	0	0	0	0	0	0	0	0
	↑				⋮														
	↓				⋮														
	bright	1	1	1	1	0	1	0	0	0	0	0	0	0	0	0	0	0	0
	1	1	1	1	1	0	0	0	0	0	0	0	0	0	0	0	0	0	
Red	1	1	1	1	1	1	0	0	0	0	0	0	0	0	0	0	0	0	
Green scale	Black	0	0	0	0	0	0	0	0	0	0	0	0	0	0	0	0	0	0
		0	0	0	0	0	0	0	0	0	0	1	0	0	0	0	0	0	0
	dark	0	0	0	0	0	0	0	0	0	1	0	0	0	0	0	0	0	0
	↑				⋮														
	↓				⋮														
	bright	0	0	0	0	0	0	1	1	1	1	0	1	0	0	0	0	0	0
	0	0	0	0	0	0	1	1	1	1	1	0	0	0	0	0	0	0	
Green	0	0	0	0	0	0	1	1	1	1	1	1	0	0	0	0	0	0	
Blue scale	Black	0	0	0	0	0	0	0	0	0	0	0	0	0	0	0	0	0	0
		0	0	0	0	0	0	0	0	0	0	0	0	0	0	0	0	0	1
	dark	0	0	0	0	0	0	0	0	0	0	0	0	0	0	0	0	1	0
	↑				⋮														
	↓				⋮														
	bright	0	0	0	0	0	0	0	0	0	0	0	0	1	1	1	1	0	1
	0	0	0	0	0	0	0	0	0	0	0	0	1	1	1	1	1	0	
Blue	0	0	0	0	0	0	0	0	0	0	0	0	1	1	1	1	1	1	

4.7 DISPLAY POSITIONS

The following table is the coordinates per pixel (See "4.8 SCANNING DIRECTIONS").

C (0, 0)						
R	G	B				
↑						
C(0, 0)	C(1, 0)	...	C(X, 0)	...	C(1022, 0)	C(1023, 0)
C(0, 1)	C(1, 1)	...	C(X, 1)	...	C(1022, 1)	C(1023, 1)
⋮	⋮	⋮	⋮	⋮	⋮	⋮
C(0, Y)	C(1, Y)	...	C(X, Y)	...	C(1022, Y)	C(1023, Y)
⋮	⋮	⋮	⋮	⋮	⋮	⋮
C(0, 766)	C(1, 766)	...	C(X, 766)	...	C(1022, 766)	C(1023, 766)
C(0, 767)	C(1, 767)	...	C(X, 767)	...	C(1022, 767)	C(1023, 767)

4.8 SCANNING DIRECTIONS

The following figures are seen from a front view. Also the arrow shows the direction of scan.

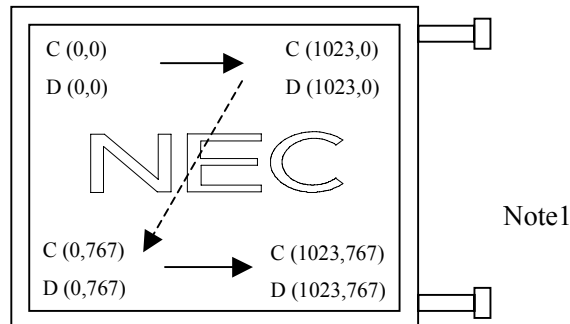

Figure 1. Normal scan (DPSR: Low or Open)

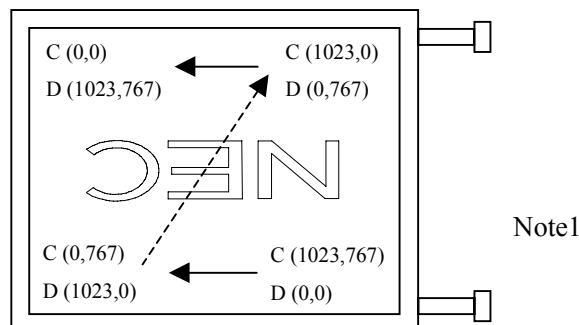

Figure 2. Reverse scan (DPSR: High)

Note1: Meaning of C (X, Y) and D (X, Y)

C (X, Y): The coordinates of the display position (See "4.7 DISPLAY POSITIONS").

D (X, Y): The data number of input signal for LCD panel signal processing board

4.9 INPUT SIGNAL TIMINGS FOR LCD PANEL SIGNAL PROCESSING BOARD

4.9.1 Outline of input signal timings

This diagram indicates virtual signal for set up to timing.

- Horizontal signal

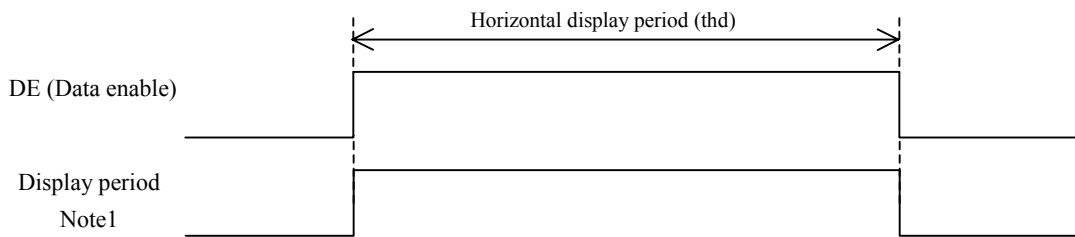

Note1: Fixed mode cannot be used while working of DE mode.

- Vertical signal

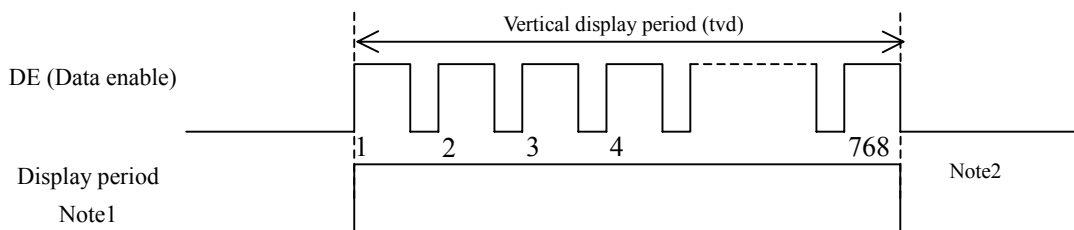

Note1: Fixed mode cannot be used while working of DE mode.

Note2: This diagram indicates virtual signal for set up to timing.

Note3: See "4.9.3 Input signal timing chart" for numeration of pulse.

4.9.2 Timing characteristics

Parameter		Symbol	Min.	Typ.	Max.	Unit	Remarks	
CLK	Frequency	1/tc	60.0	65.0	68.0	MHz	15.385 ns (typ.)	
	Duty	-	-			-	Note2	
	Rise time, Fall time	-				ns		
DATA	CLK-DATA	Setup time	-			ns	Note2	
		Hold time				ns		
	Rise time, Fall time	-				ns		
DE	Horizontal	Cycle	th	19.67	20.676	22.4	μ s	48.363 kHz (typ.) Note1, Note2, Note3
		Display period	thd	1024			CLK	
	Vertical (One frame)	Cycle	tv	13.3	16.666	18.5	ms	
			Display period	tvd	768			H
		CLK-DE	Setup time	-	-			ns
	Hold time		-	ns				
	Rise time, Fall time		-					ns

Note1: Definition of parameters is as follows.

$$t_c = 1\text{CLK}, t_h = 1\text{H}$$

Note2: See the data sheet of LVDS transmitter.

Note3: "th" must keep the fluctuation within ± 1 CLK, because of avoidance of image sticking.

4.9.3 Input signal timing chart

Horizontal timing

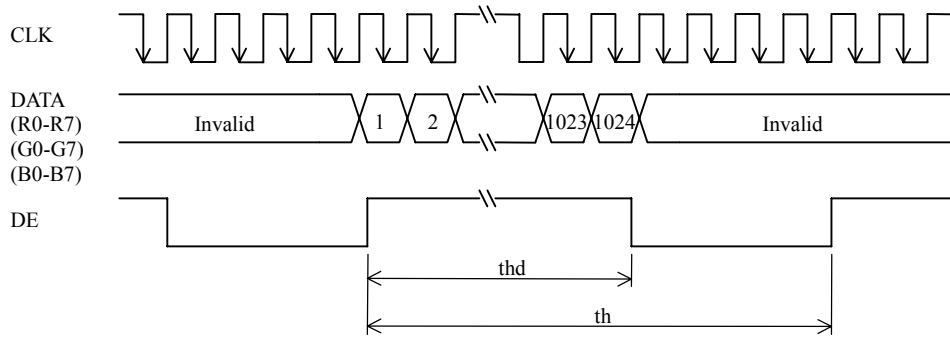

Vertical timing

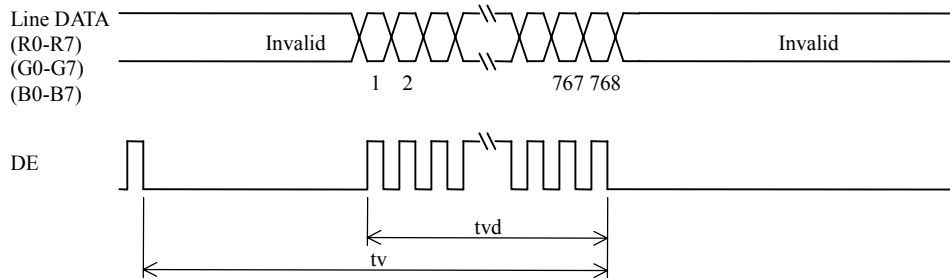

4.10 OPTICS

4.10.1 Optical characteristics

Parameter	Note1	Condition	Symbol	Min.	Typ.	Max.	Unit	Remarks
Luminance		White at center $\theta_R = 0^\circ, \theta_L = 0^\circ, \theta_U = 0^\circ, \theta_D = 0^\circ$	L	200	250	-	cd/m ²	-
Contrast ratio		White/Black at center $\theta_R = 0^\circ, \theta_L = 0^\circ, \theta_U = 0^\circ, \theta_D = 0^\circ$	CR	150	500	-	-	Note2
Peak contrast		White/Black at center $\theta_R = 0^\circ, \theta_L = 0^\circ, \theta_D = 50^\circ$	CRmax	-	400	-	-	
Luminance uniformity		-	LU	-	1.25	1.40	-	Note3
Chromaticity	White	x coordinate	Wx	-	0.323	-	-	Note4
		y coordinate	Wy	-	0.340	-	-	
	Red	x coordinate	Rx	-	0.594	-	-	
		y coordinate	Ry	-	0.349	-	-	
	Green	x coordinate	Gx	-	0.339	-	-	
		y coordinate	Gy	-	0.521	-	-	
Blue	x coordinate	Bx	-	0.158	-	-		
	y coordinate	By	-	0.162	-	-		
Color gamut		$\theta_R = 0^\circ, \theta_L = 0^\circ, \theta_U = 0^\circ, \theta_D = 0^\circ$ at center, against NTSC color space	C	35	40	-	%	
Response time		White to black	Ton	-	6	15	ms	Note5 Note6
		Black to white	Toff	-	15	30	ms	
Viewing angle	Right	$\theta_U = 0^\circ, \theta_D = 0^\circ, CR = 10$	θ_R	-	60	-	°	Note7
	Left	$\theta_U = 0^\circ, \theta_D = 0^\circ, CR = 10$	θ_L	-	60	-	°	
	Up	$\theta_R = 0^\circ, \theta_L = 0^\circ, CR = 10$	θ_U	-	45	-	°	
	Down	$\theta_R = 0^\circ, \theta_L = 0^\circ, CR = 10$	θ_D	-	60	-	°	

Note1: Measurement conditions are as follows.

Ta = 25°C, VCC = 3.3V, IBL = 5.0mAmps/lamp, Display mode: XGA, Horizontal cycle = 48.363kHz, Vertical cycle = 60.0Hz, DPSR= Low or Open: Normal scan

Optical characteristics are measured at luminance saturation after 20minutes from working the product, in the dark room. Also measurement method for luminance is as follows.

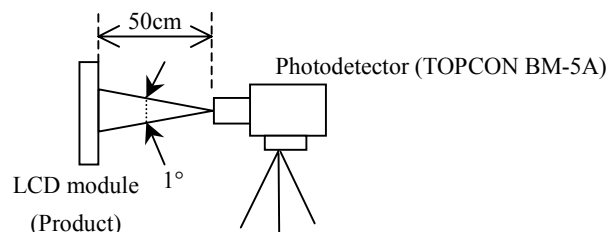

Note2: See "4.10.2 Definition of contrast ratio".

Note3: See "4.10.3 Definition of luminance uniformity".

Note4: These coordinates are found on CIE 1931 chromaticity diagram.

Note5: Product surface temperature: TopF = 34°C

Note6: See "4.10.4 Definition of response times".

Note7: See "4.10.5 Definition of viewing angles".

4.10.2 Definition of contrast ratio

The contrast ratio is calculated by using the following formula.

$$\text{Contrast ratio (CR)} = \frac{\text{Luminance of white screen}}{\text{Luminance of black screen}}$$

4.10.3 Definition of luminance uniformity

The luminance uniformity is calculated by using following formula.

$$\text{Luminance uniformity (LU)} = \frac{\text{Maximum luminance from ① to ⑤}}{\text{Minimum luminance from ① to ⑤}}$$

The luminance is measured at near the 5 points shown below.

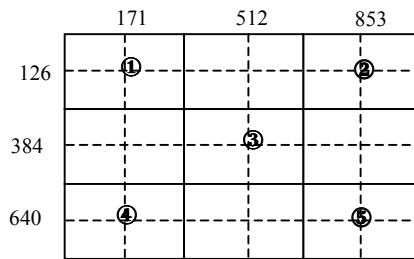

4.10.4 Definition of response times

Response time is measured, the luminance changes from "white" to "black", or "black" to "white" on the same screen point, by photo-detector. Ton is the time it takes the luminance change from 90% down to 10%. Also Toff is the time it takes the luminance change from 10% up to 90% (See the following diagram.).

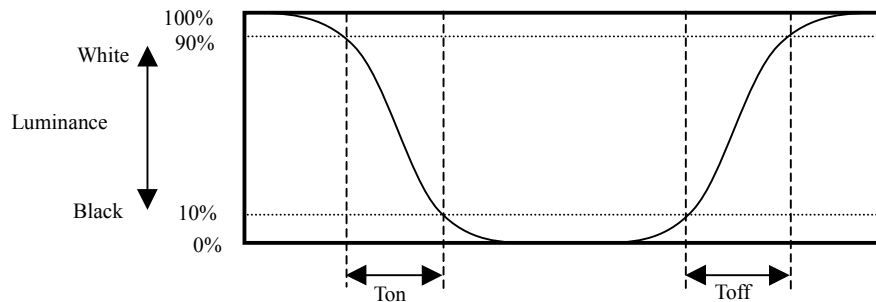

4.10.5 Definition of viewing angles

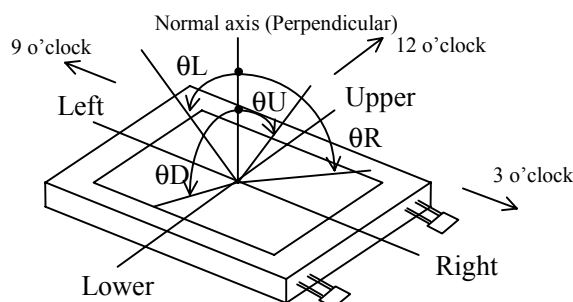

5. RELIABILITY TESTS

Test item	Condition	Judgement
High temperature and humidity (Operation)	① 55 ± 2°C, RH = 85%, 240hours ② Display data is black.	No display malfunctions Note1
High temperature (Operation)	① 65 ± 2°C, 240hours ② Display data is black.	
Heat cycle (Operation)	① 0 ± 3°C...1hour 65 ± 3°C...1hour ② 50cycles, 4hours/cycle ③ Display data is black.	
Thermal shock (Non operation)	① -20 ± 3°C...30minutes 80 ± 3°C...30minutes ② 100cycles, 1hour/cycle ③ Temperature transition time is within 5 minutes.	
ESD (Operation)	① 150pF, 150Ω, ±10kV ② 9 places on a panel surface Note2 ③ 10 times each places at 1 sec interval	
Dust (Operation)	① Sample dust: No. 15 (by JIS-Z8901) ② 15 seconds stir ③ 8 times repeat at 1 hour interval	
Vibration (Non operation)	① 5 to 100Hz, 19.6m/s ² ② 1 minute/cycle ③ X, Y, Z direction ④ 120 times each directions	No display malfunctions Note1 No physical damages
Mechanical shock (Non operation)	① 539m/ s ² , 11ms ② ±X, ±Y, ±Z direction ③ 5 times each directions	

Note1: Display functions are checked under the same conditions as product inspection.

Note2: See the following figure for discharge points.

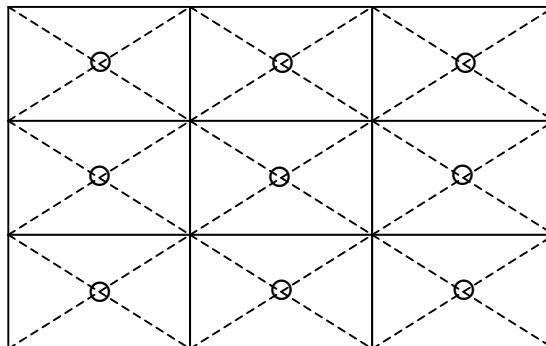

6. PRECAUTIONS

6.1 MEANING OF CAUTION SIGNS

The following caution signs have very important meaning. **Be sure to read "6.2 CAUTIONS", and "7.3 ATTENTIONS" after understanding this contents!**



This sign has the meaning that customer will be injured by himself or the product will sustain a damage, if customer has wrong operations.



This sign has the meaning that customer will get an electrical shock, if customer has wrong operations.



This sign has the meaning that customer will be injured by himself, if customer has wrong operations.

6.2 CAUTIONS



*** Do not touch the lamp cables while turn on. Customer will be in danger of an electric shock.**



*** Do not touch the backlight while turn on. Customer will be in danger of burn injury.**
*** Do not shock and press the LCD panel and the backlight! There is a danger of breaking, because they are made of glass. (Shock: To be not greater 539m/s² and to be not greater 11ms, Pressure: To be not greater 19.6N)**

6.3 ATTENTIONS



6.3.1 Handling of the product

- ① Take hold of both ends without touch the circuit board when customer pulls out products (LCD modules) from inner packing box. If customer touches it, products may be broken down or out of adjustment, because of stress to mounting parts.
- ② Do not hook cables nor pull connection cables such as lamp cable and so on, for fear of damage.
- ③ If customer puts down the product temporarily, the product puts on flat subsoil as a display side turns down.
- ④ Take the measures of electrostatic discharge such as earth band, ionic shower and so on, when customer deals with the product, because products may be damaged by electrostatic.
- ⑤ The torque for mounting screws must never exceed 0.2N·m. Higher torque values might result in distortion of the bezel.
- ⑥ The product must be installed using mounting holes without undue stress such as bends or twist (See outline drawings). And do not add undue stress to any portion (such as bezel flat area) except mounting hole portion.
 Bends or twist described above and undue stress to any portion except mounting hole portion may cause display un-uniformity.

- ⑦ Do not press or rub on the sensitive display surface. If customer clean on the panel surface, NEC recommends using the cloth with ethanolic liquid such as screen cleaner for LCD.
- ⑧ Do not push-pull the interface connectors while the product is working, because wrong power sequence may break down the product.
- ⑨ Do not bend or unbend the lamp cable at the near part of the lamp holding rubber, to avoid the damage for high voltage side of the lamp. This damage may cause a lamp breaking and abnormal operation of high voltage circuit.

6.3.2 Environment

- ① Do not operate or store in high temperature, high humidity, dewdrop atmosphere or corrosive gases. Keep the product in antistatic pouch in room temperature, because of avoidance for dusts and sunlight, if customer stores the product.
- ② In order to prevent dew condensation occurring by temperature difference, the product packing box must be opened after leave under the environment of an unpacking room temperature enough. Because a situation of dew condensation occurring is changed by the environmental temperature and humidity, evaluate the leaving time sufficiently. (Recommendation leaving time: 6 hour or more with packing state)
- ③ Do not operate in high magnetic field. Circuit boards may be broken down by it.
- ④ This product is not designed as radiation hardened.
- ⑤ Use an original protection sheet on the product surface (polarizer). Adhesive type protection sheet should be avoided, because it may change color or properties of the polarizer.

6.3.3 Characteristics

The following items are neither defects nor failures.

- ① Response time, luminance and color may be changed by ambient temperature.
- ② The LCD may be seemed luminance non-uniformity, flicker, vertical seam or small spot by display patterns.
- ③ Optical characteristics (e.g. luminance, display uniformity, etc.) gradually is going to change depending on operating time, and especially low temperature, because the LCD has cold cathode fluorescent lamps.
- ④ Do not display the fixed pattern for a long time because it may cause image sticking. Use a screen saver, if the fixed pattern is displayed on the screen.
- ⑤ The display color may be changed by viewing angle because of the use of condenser sheet in the backlight unit.
- ⑥ Optical characteristics may be changed by input signal timings.
- ⑦ The interference noise of input signal frequency for this product's signal processing board and luminance control frequency of customer's backlight inverter may appear on a display. Set up luminance control frequency of backlight inverter so that the interference noise does not appear.

6.3.4 Other

- ① All GND, backlight inverter ground (GNDB), VCC and backlight inverter power supply voltage (VDDDB) terminals should be used without a non-connected line.
- ② Do not disassemble a product or adjust volume without permission of NEC.
- ③ See "REPLACEMENT MANUAL FOR LAMP HOLDER", if customer would like to replace backlight lamps.
- ④ Pay attention not to insert waste materials inside of products, if customer uses screwnails.
- ⑤ Pack the product with original shipping package, because of avoidance of some damages during transportation, when customer returns it to NEC for repair and so on.

7. OUTLINE DRAWINGS

7.1 FRONT VIEW

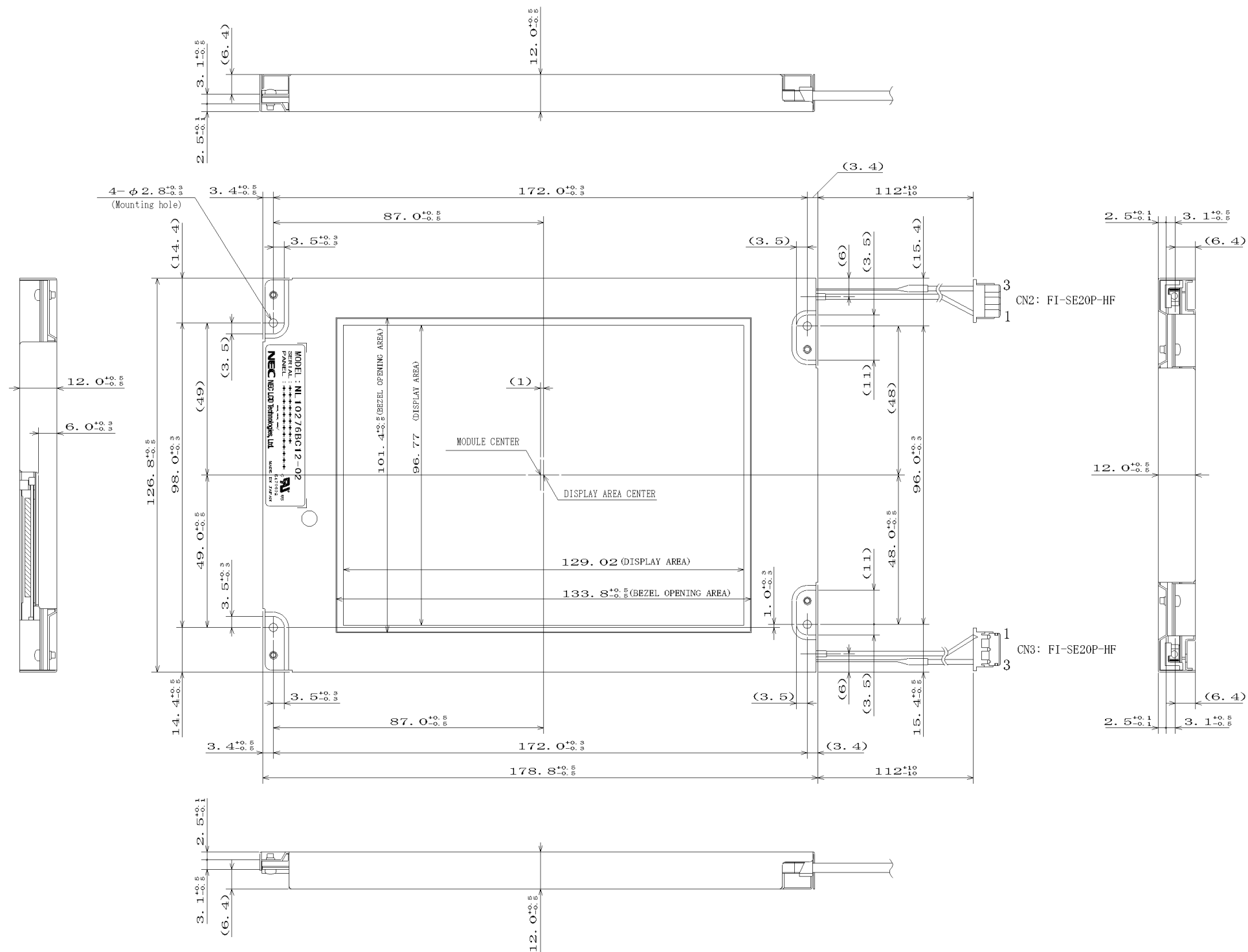

Unit: mm

Note1: The values in parentheses are for reference.

Note2: The torque for mounting screw should never exceed 0.2N·m.

7.2 REAR VIEW

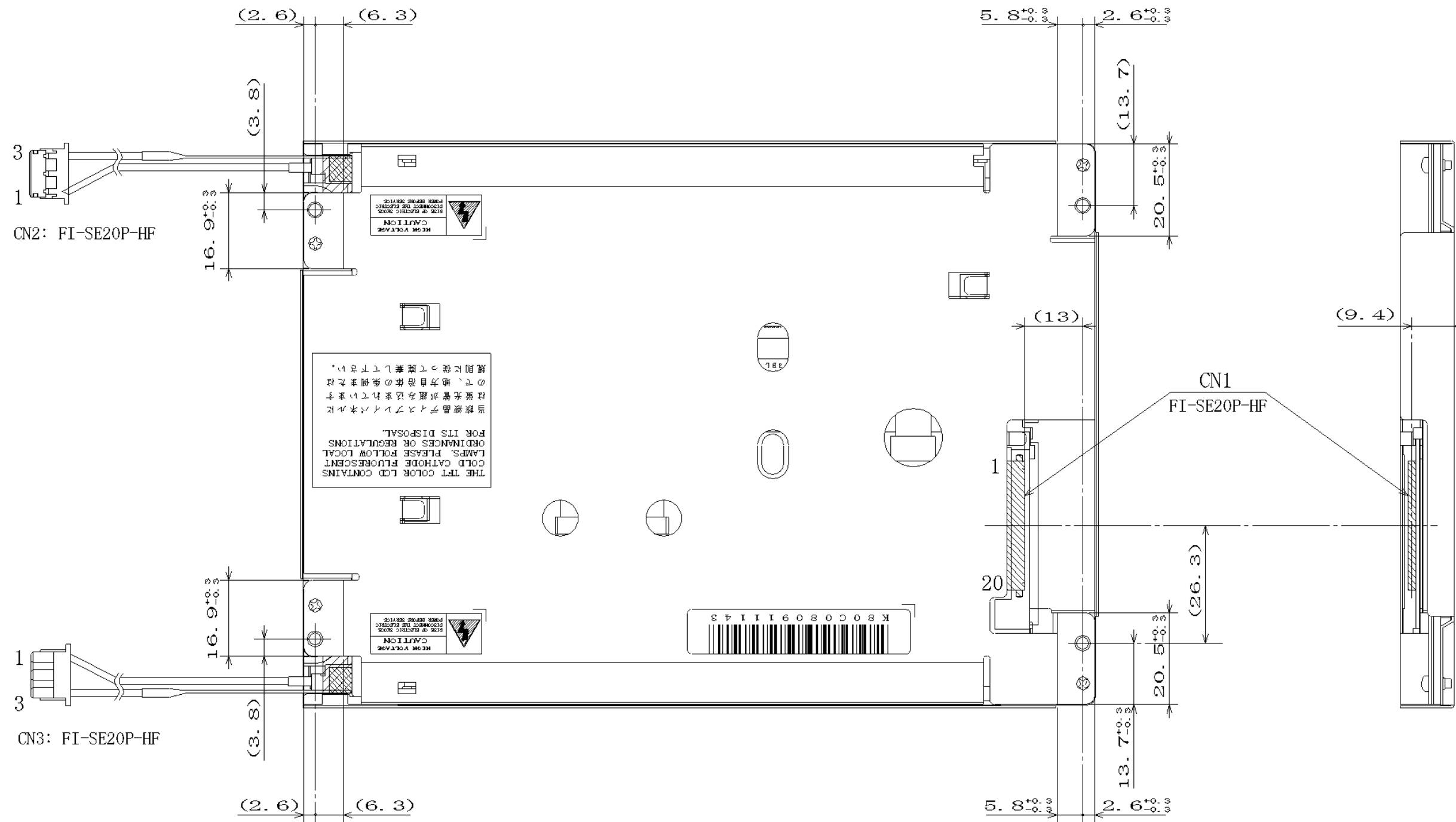

Unit: mm

Note1: The values in parentheses are for reference.

Note2: The torque for mounting screw should never exceed 0.2N·m.