

Model Name: T460HW03 VF

Issue Date : 2009/10/05

(*)Preliminary Specifications

()Final Specifications

Customer Signature	Date	AUO	Date
Approved By _____		Approval By PM Director <i>Frank Hsu</i> _____	
Note		Reviewed By RD Director <i>Eugene Chen</i> _____	
		Reviewed By Project Leader <i>Evan Chen</i> _____	
		Prepared By PM <i>Ryan Chung</i> _____	

Contents

No		
		CONTENTS
		RECORD OF REVISIONS
1		GENERAL DESCRIPTION
2		ABSOLUTE MAXIMUM RATINGS
3		ELECTRICAL SPECIFICATION
	3-1	ELECTRICAL CHARACTERISTICS
	3-2	INTERFACE CONNECTIONS
	3-3	SIGNAL TIMING SPECIFICATION
	3-4	SIGNAL TIMING WAVEFORM
	3-5	COLOR INPUT DATA REFERENCE
	3-6	POWER SEQUENCE
	3-7	BACKLIGHT SPECIFICATION
4		OPTICAL SPECIFICATION
5		MECHANICAL CHARACTERISTICS
6		RELIABILITY TEST ITEMS
7		INTERNATIONAL STANDARD
	7-1	SAFETY
	7-2	EMC
8		PACKING
	8-1	DEFINITION OF LABEL
	8-2	PACKING METHODS
	8-3	PALLET AND SHIPMENT INFORMATION
9		PRECAUTION
	9-1	MOUNTING PRECAUTIONS
	9-2	OPERATING PRECAUTIONS
	9-3	ELECTROSTATIC DISCHARGE CONTROL
	9-4	PRECAUTIONS FOR STRONG LIGHT EXPOSURE
	9-5	STORAGE
	9-6	HANDLING PRECAUTIONS FOR PROTECT FILM

1. General Description

This specification applies to the 46 inch Color TFT-LCD Module T460HW03 VF. This LCD module has a TFT active matrix type liquid crystal panel 1920 x 1080 pixels, and diagonal size of 46 inch. This module supports 1920 x 1080 mode. Each pixel is divided into Red, Green and Blue sub-pixels or dots which are arranged in vertical stripes. Gray scale or the brightness of the sub-pixel color is determined with a 8-bit gray scale signal for each dot.

The T460HW03 VF has been designed to apply the 8-bit 2 channel LVDS interface method. It is intended to support displays where high brightness, wide viewing angle, high color saturation, and high color depth are very important.

* General Information

Items	Specification	Unit	Note
Active Screen Size	46	inch	
Display Area	1018.08(H) x 572.67(V)	mm	
Outline Dimension	1083.0(H) x 627.0(V) x 59.0(D)	mm	With Inverter
Driver Element	a-Si TFT active matrix		
Display Colors	8 bit, 16.7M	Colors	
Number of Pixels	1920 x 1080	Pixel	
Pixel Pitch	0.53025	mm	
Pixel Arrangement	RGB vertical stripe		
Display Operation Mode	Normally Black		
Surface Treatment	Anti-Glare, 3H		Haze=13%

2. Absolute Maximum Ratings

The followings are maximum values which, if exceeded, may cause faulty operation or damage to the unit

Item	Symbol	Min	Max	Unit	Conditions
Logic/LCD Drive Voltage	Vcc	-0.3	14	[Volt]	Note 1
Input Voltage of Signal	Vin	-0.3	4	[Volt]	Note 1
Operating Temperature	TOP	0	+50	[°C]	Note 2
Operating Humidity	HOP	10	90	[%RH]	Note 2
Storage Temperature	TST	-20	+60	[°C]	Note 2
Storage Humidity	HST	10	90	[%RH]	Note 2
Panel Surface Temperature	PST	-	65	[°C]	Note 3

Note 1: Duration:50 msec.

Note 2 : Maximum Wet-Bulb should be 39°C and No condensation.

The relative humidity must not exceed 90% non-condensing at temperatures of 40°C or less. At temperatures greater than 40°C, the wet bulb temperature must not exceed 39°C.

Note 3: Surface temperature is measured at 50°C Dry condition

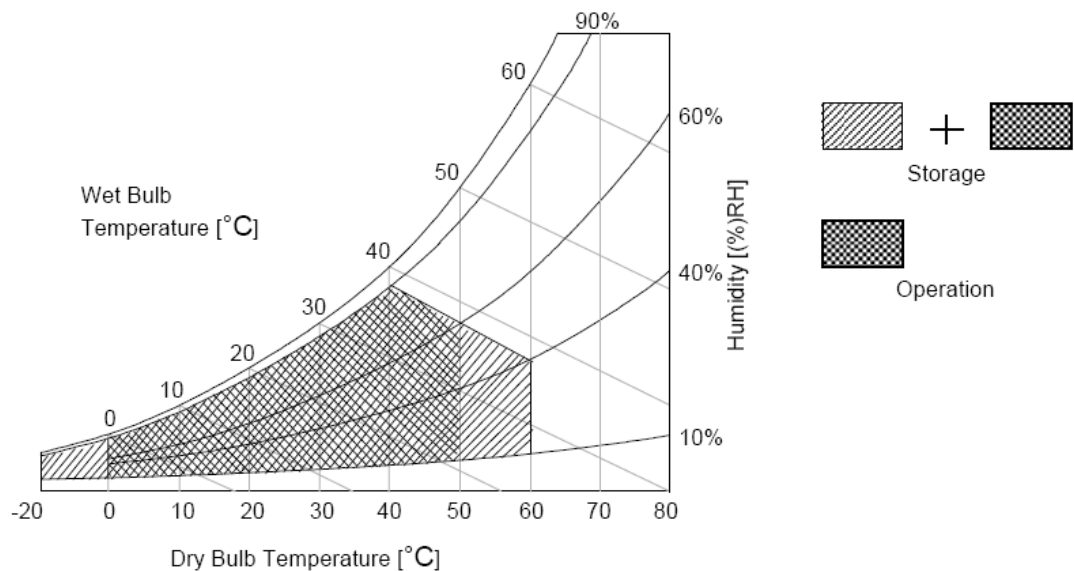

3. Electrical Specification

The T460HW03 VF requires two power inputs. One is employed to power the LCD electronics and to drive the TFT array and liquid crystal. The second input for BLU is to power inverter.

3.1 Electrical Characteristics

Parameter		Symbol	Value			Unit	Note
			Min.	Typ.	Max		
LCD							
Power Supply Input Voltage		V_{DD}	10.8	12	13.2	V_{DC}	1
Power Supply Input Current		I_{DD}	--	1.32	1.45	A	2
Power Consumption		P_C	--	15.84	17.40	Watt	2
Inrush Current		I_{RUSH}	--	--	4	A	3
LVDS Interface	Differential Input High Threshold Voltage	V_{TH}	--	--	+100	4	4
	Differential Input Low Threshold Voltage	V_{TL}	-100	--	--	4	4
	Input Common Mode Voltage	V_{ICM}	1.10	1.25	1.40	V_{DC}	4
CMOS Interface	Input High Threshold Voltage	V_{IH} (High)	2.4	--	3.3	V_{DC}	--
	Input Low Threshold Voltage	V_{IL} (Low)	0	--	0.6	V_{DC}	--
Backlight Power Consumption		P_{BL}	159.6	168	176.4	Watt	--
Life Time			50,000		--	Hours	8

Note :

1. The ripple voltage should be controlled under 10% of V_{CC}
2. $V_{DD} = 12.0V$, $F_V = 60Hz$, $F_{CLK} = 82MHz$, $25^\circ C$, Test Pattern : White Pattern
>> refer to "Section:3.3 Signal Timing Specification, Typical timing"
3. Measurement condition : Rising time = 400us

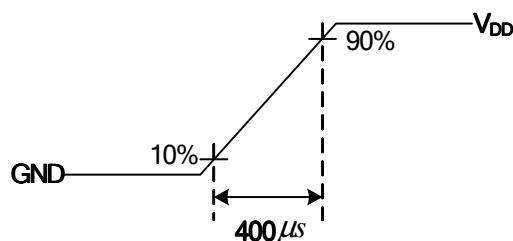

4. $V_{ICM} = 1.25V$

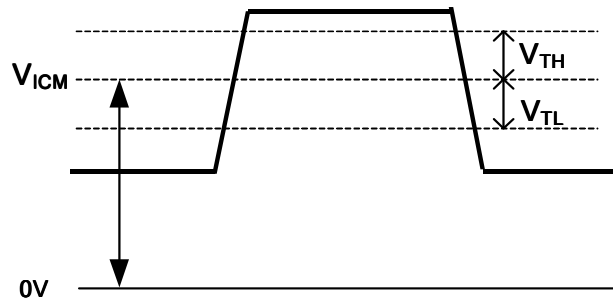

5. Input Channel Pair Skew Margin

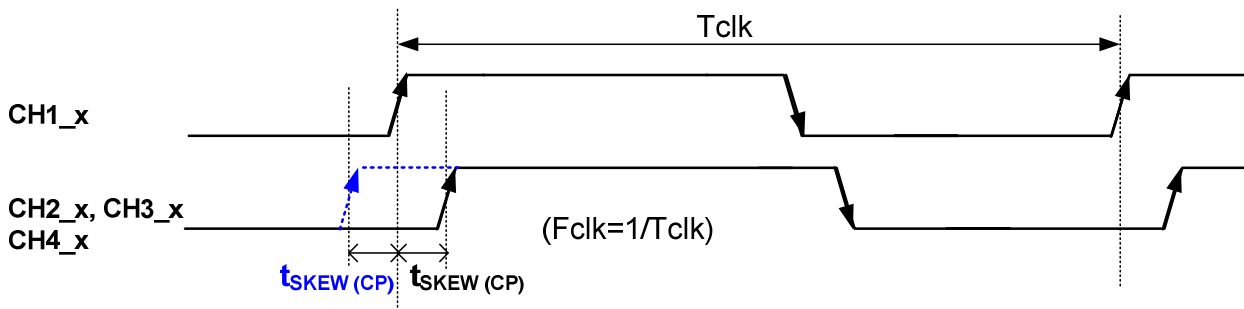

3.2 Interface Connections

- LCD connector: **CN1:FI-RE51S-HF (JAE, LVDS connector)** TBD
- Mating connector: **FI-RE51S-HL (JAE)** TBD

PIN	Symbol	Description	PIN	Symbol	Description
1	V _{DD}	Power Supply, +12V DC Regulated	26	CH2_0+	LVDS Channel 2, Signal 0+
2	V _{DD}	Power Supply, +12V DC Regulated	27	CH2_1-	LVDS Channel 2, Signal 1-
3	V _{DD}	Power Supply, +12V DC Regulated	28	CH2_1+	LVDS Channel 2, Signal 1+
4	V _{DD}	Power Supply, +12V DC Regulated	29	CH2_2-	LVDS Channel 2, Signal 2-
5	V _{DD}	Power Supply, +12V DC Regulated	30	CH2_2+	LVDS Channel 2, Signal 2+
6	NC	No connection	31	GND	Ground
7	GND	Ground	32	CH2_CLK-	LVDS Channel 2, Clock -
8	GND	Ground	33	CH2_CLK+	LVDS Channel 2, Clock +
9	GND	Ground	34	GND	Ground
10	CH1_0-	LVDS Channel 1, Signal 0-	35	CH2_3-	LVDS Channel 2, Signal 3-
11	CH1_0+	LVDS Channel 1, Signal 0+	36	CH2_3+	LVDS Channel 2, Signal 3+
12	CH1_1-	LVDS Channel 1, Signal 1-	37	Reserved	AUO Internal Use Only
13	CH1_1+	LVDS Channel 1, Signal 1+	38	Reserved	AUO Internal Use Only
14	CH1_2-	LVDS Channel 1, Signal 2-	39	GND	Ground
15	CH1_2+	LVDS Channel 1, Signal 2+	40	SCL	EEPROM Serial Clock
16	GND	Ground	41	NC	No connection
17	CH1_CLK-	LVDS Channel 1, Clock -	42	NC	No connection
18	CH1_CLK+	LVDS Channel 1, Clock +	43	WP	EEPROM Write Protection High(3.3V) for Writable, Low(GND) for Protection
19	GND	Ground	44	SDA	EEPROM Serial Data
20	CH1_3-	LVDS Channel 1, Signal 3-	45	LVDS_SEL	Open/High(3.3V) for NS, Low(GND) for JEIDA
21	CH1_3+	LVDS Channel 1, Signal 3+	46	NC	No connection
22	Reserved	AUO Internal Use Only	47	NC	No connection
23	Reserved	AUO Internal Use Only	48	NC	No connection
24	GND	Ground	49	NC	No connection
25	CH2_0-	LVDS Channel 2, Signal 0-	50	NC	No connection
			51	Reserved	AUO Internal Use Only

LVDS Option = High/Open→NS

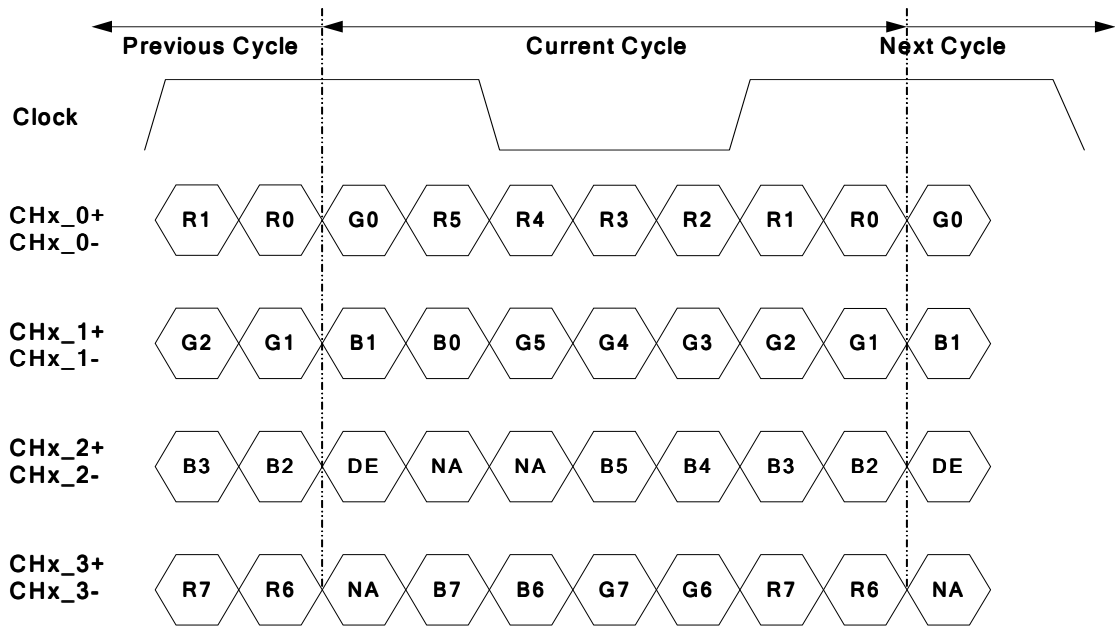

Note: x = 1, 2, 3, 4...

LVDS Option = Low/GND→JEIDA

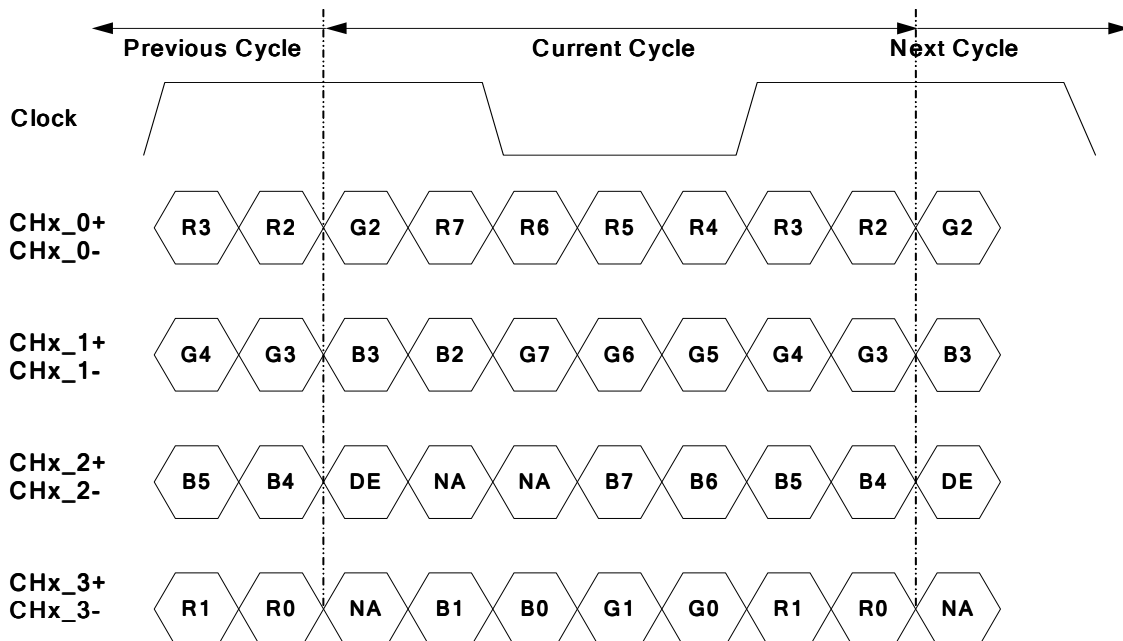

Note: x = 1, 2, 3, 4...

3.3 Signal Timing Specification

This is the signal timing required at the input of the user connector. All of the interface signal timing should be satisfied with the following specifications for its proper operation.

Signal	Item	Symbol	Min.	Typ.	Max	Unit
Vertical Section	Period	Tv	1090	1125	1480	Th
	Active	Tdisp (v)	1080			Th
	Blanking	Tblk (v)	10	45	400	Th
Horizontal Section	Period	Th	1030	1100	1325	Tclk
	Active	Tdisp (h)	960			Tclk
	Blanking	Tblk (h)	70	140	365	Tclk
Clock	Frequency	Fclk=1/Tclk	50	74.25	82	MHz
Vertical Frequency	Frequency	Fv	47	60	63	Hz
Horizontal Frequency	Frequency	Fh	60	67.5	73	KHz

Notes:

(1) Display position is specific by the rise of DE signal only.

Horizontal display position is specified by the rising edge of 1st DCLK after the rise of 1st DE, is displayed on the left edge of the screen.

(2) Vertical display position is specified by the rise of DE after a “Low” level period equivalent to eight times of horizontal period. The 1st data corresponding to one horizontal line after the rise of 1st DE is displayed at the top line of screen.

(3) If a period of DE “High” is less than 1920 DCLK or less than 1080 lines, the rest of the screen displays black.

(4) The display position does not fit to the screen if a period of DE “High” and the effective data period do not synchronize with each other.

3.4 Signal Timing Waveforms

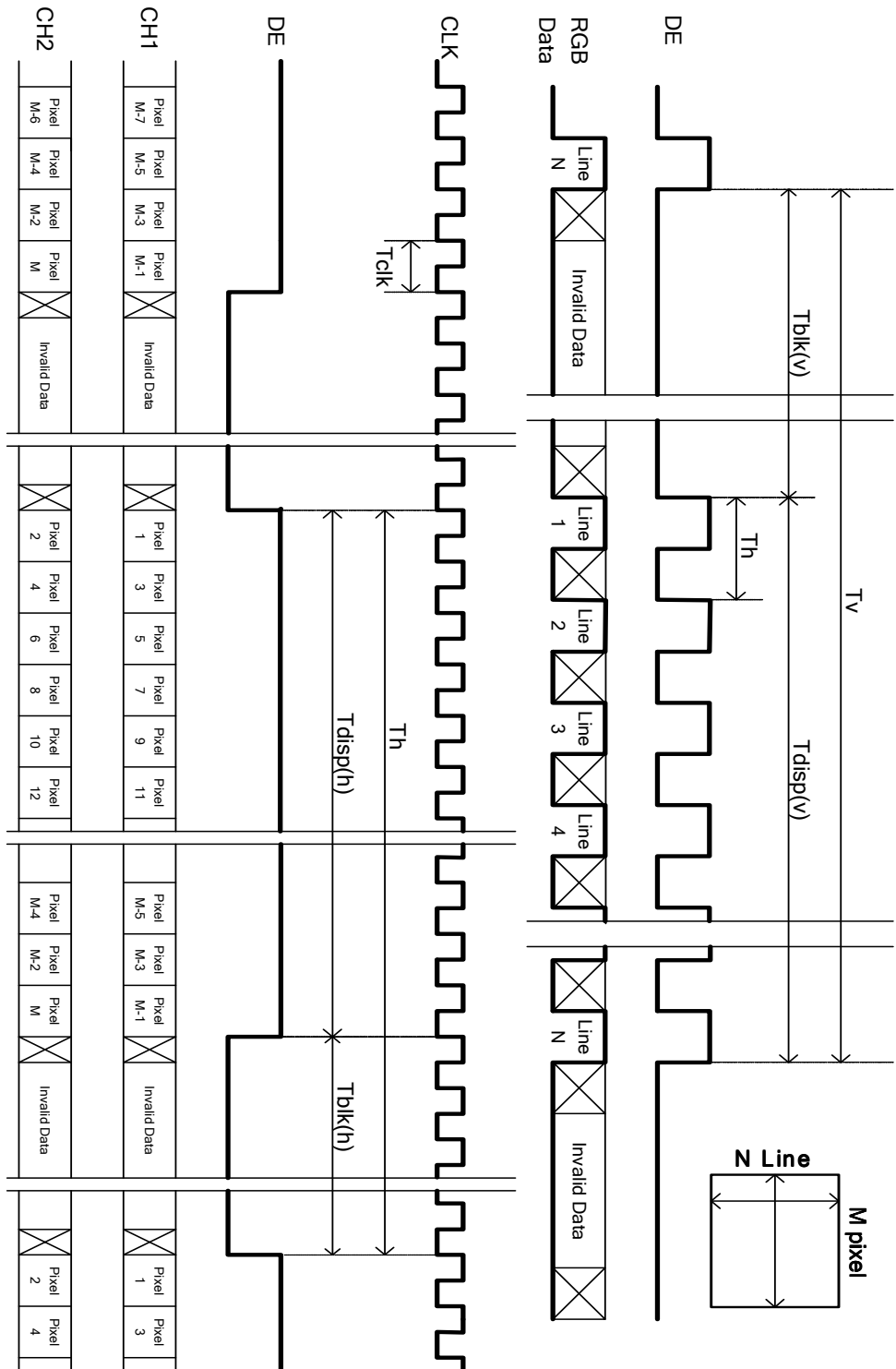

3.5 Color Input Data Reference

The brightness of each primary color (red, green and blue) is based on the 8 bit gray scale data input for the color; the higher the binary input, the brighter the color. The table below provides a reference for color versus data input.

Color Data Reference

Color		Input Color Data																							
		RED								GREEN								BLUE							
		MSB				LSB				MSB				LSB				MSB				LSB			
		R7	R6	R5	R4	R3	R2	R1	R0	G7	G6	G5	G4	G3	G2	G1	G0	B7	B6	B5	B4	B3	B2	B1	B0
Basic Color	Black	0	0	0	0	0	0	0	0	0	0	0	0	0	0	0	0	0	0	0	0	0	0	0	0
	Red(255)	1	1	1	1	1	1	1	1	0	0	0	0	0	0	0	0	0	0	0	0	0	0	0	0
	Green(255)	0	0	0	0	0	0	0	0	1	1	1	1	1	1	1	1	0	0	0	0	0	0	0	0
	Blue(255)	0	0	0	0	0	0	0	0	0	0	0	0	0	0	0	0	1	1	1	1	1	1	1	1
	Cyan	0	0	0	0	0	0	0	0	1	1	1	1	1	1	1	1	1	1	1	1	1	1	1	1
	Magenta	1	1	1	1	1	1	1	1	0	0	0	0	0	0	0	0	1	1	1	1	1	1	1	1
	Yellow	1	1	1	1	1	1	1	1	1	1	1	1	1	1	1	1	0	0	0	0	0	0	0	0
	White	1	1	1	1	1	1	1	1	1	1	1	1	1	1	1	1	1	1	1	1	1	1	1	1
R	RED(000)	0	0	0	0	0	0	0	0	0	0	0	0	0	0	0	0	0	0	0	0	0	0	0	0
	RED(001)	0	0	0	0	0	0	0	1	0	0	0	0	0	0	0	0	0	0	0	0	0	0	0	0

	RED(254)	1	1	1	1	1	1	1	0	0	0	0	0	0	0	0	0	0	0	0	0	0	0	0	0
	RED(255)	1	1	1	1	1	1	1	1	0	0	0	0	0	0	0	0	0	0	0	0	0	0	0	0
G	GREEN(000)	0	0	0	0	0	0	0	0	0	0	0	0	0	0	0	0	0	0	0	0	0	0	0	0
	GREEN(001)	0	0	0	0	0	0	0	0	0	0	0	0	0	0	1	0	0	0	0	0	0	0	0	0

	GREEN(254)	0	0	0	0	0	0	0	0	1	1	1	1	1	1	1	0	0	0	0	0	0	0	0	0
	GREEN(255)	0	0	0	0	0	0	0	0	1	1	1	1	1	1	1	1	0	0	0	0	0	0	0	0
B	BLUE(000)	0	0	0	0	0	0	0	0	0	0	0	0	0	0	0	0	0	0	0	0	0	0	0	0
	BLUE(001)	0	0	0	0	0	0	0	0	0	0	0	0	0	0	0	0	0	0	0	0	0	0	0	1

	BLUE(254)	0	0	0	0	0	0	0	0	0	0	0	0	0	0	0	0	1	1	1	1	1	1	1	0
	BLUE(255)	0	0	0	0	0	0	0	0	0	0	0	0	0	0	0	0	1	1	1	1	1	1	1	1

3.6 Power Sequence for LCD

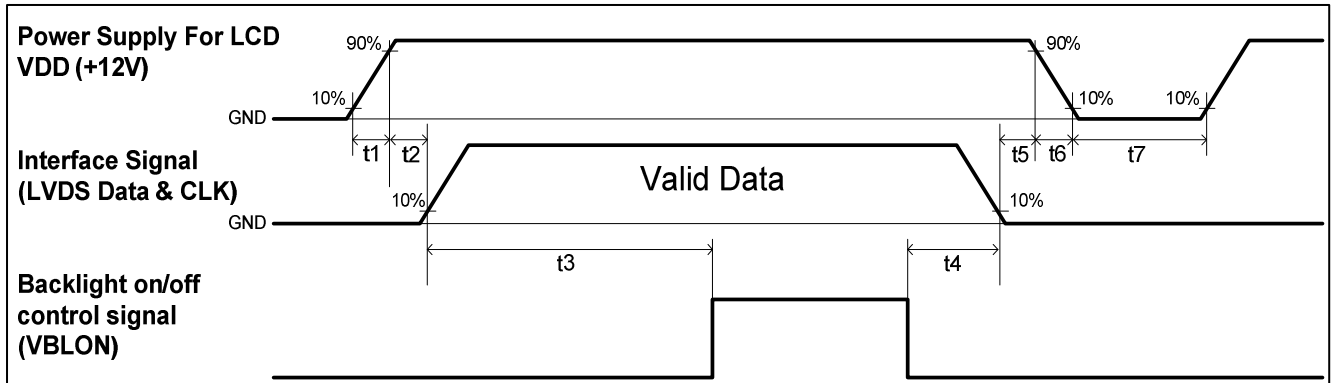

Parameter	Values			Unit
	Min.	Type.	Max.	
t1	0.4	---	30	ms
t2	0.1	---	---	ms
t3	300	---	---	ms
t4	0 ^{*1}	---	---	ms
t5	0	---	---	ms
t6	---	---	--- ^{*2}	ms
t7	500	---	---	ms

Note:

- (1) T4=0 : concern for residual pattern before BLU turn off.
- (2) T6 : voltage of VDD must decay smoothly after power-off. (customer system decide this value)

3.7 Backlight Specification

The backlight unit contains 12 CCFLs (Cold Cathode Fluorescent Lamp)

3.7.1: Electrical specification

Item	Symbol	Condition	Spec			Unit	Note	
			Min	Typ	Max			
Input Voltage	V _{DDB}	-	21.6	24	26.4	VDC	-	
Input Current	I _{DDB}	V _{DDB} =24V	6.65	7	7.35	ADC	1	
Input Power	P _{DDB}	V _{DDB} =24V	159.6	168	176.4	W	1	
Inrush Current	I _{RUSH}	V _{DDB} =24V	-	-	TBD	ADC	2	
On/Off control voltage	V _{B_{LON}}	ON	V _{DDB} =24V	2	-	5.5	VDC	-
		OFF		0	-	0.8		-
On/Off control current	I _{B_{LON}}	V _{DDB} =24V	-	-	1.5	mA	-	
Dimming Control Voltage	V _{DIM}	MAX	V _{DDB} =24V	3.0	-	3.3	VDC	-
		MIN		-	0	-	VDC	-
Dimming Control Current	I _{DIM}	V _{DDB} =24V	-	-	2	mADC	-	
Internal Dimming Ratio	DIM_R	V _{DDB} =24V	10	-	100	%	3	
External PWM Control Voltage	V _{EPWM}	MAX	V _{DDB} =24V	2	-	3.3	VDC	-
		MIN	V _{DDB} =24V	0	-	0.8		-
External PWM Control Current	I _{EPWM}	V _{DDB} =24V	-	-	2	mADC	-	
External PWM Duty ratio	D _{EPWM}	V _{DDB} =24V	10	-	100	%	3	
External PWM Frequency	F _{EPWM}	V _{DDB} =24V	140	180	240	Hz	-	

Note 1 : Dimming ratio= 100% (MAX) (Ta=25±5°C, Turn on for 45minutes)

Note 2: Measurement condition Rising time = 20ms (V_{DDB} : 10%~90%);

Note 3: Less than 10% dimming control is functional well and no backlight shutdown happened.

3.7.2: Input Pin Assignment

CN2: **CI0114M1HRL-NH (Cvilux)** TBD

Pin	Symbol	Description
1	VDDDB	Operating Voltage Supply, +24V DC regulated
2	VDDDB	Operating Voltage Supply, +24V DC regulated
3	VDDDB	Operating Voltage Supply, +24V DC regulated
4	VDDDB	Operating Voltage Supply, +24V DC regulated
5	VDDDB	Operating Voltage Supply, +24V DC regulated
6	BLGND	Ground and Current Return
7	BLGND	Ground and Current Return
8	BLGND	Ground and Current Return
9	BLGND	Ground and Current Return
10	BLGND	Ground and Current Return
11	DET	BLU status detection: Normal : 0~0.8V ; Abnormal : Open collector
12	VBLON	BLU On-Off control: High/Open (3.3V~5.5V) : BL On ; Low (0~0.8V/GND) : BL off
13	VDIM(**)	Internal PWM (0~3.3V for 10~100% Duty, open for 100%) < NC ; at External PWM mode >
14	PDIM(*)	External PWM (10%~100% Duty, open for 100%) < NC ; at Internal PWM mode >

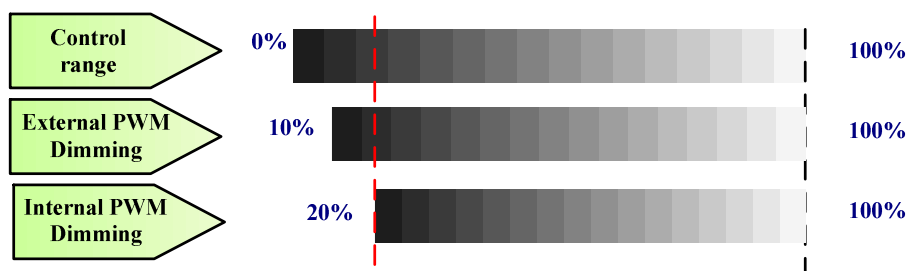

PWM Dimming : include Internal and External PWM Dimming

(Note*) IF External PWM function includes 10% dimming ratio. Judge condition as below:

- 1.) Backlight module must be lighted ON normally.
- 2.) All protection function must work normally.
- 3.) Uniformity and flicker could NOT be guaranteed!

3.7.3 Power Sequence for Inverter

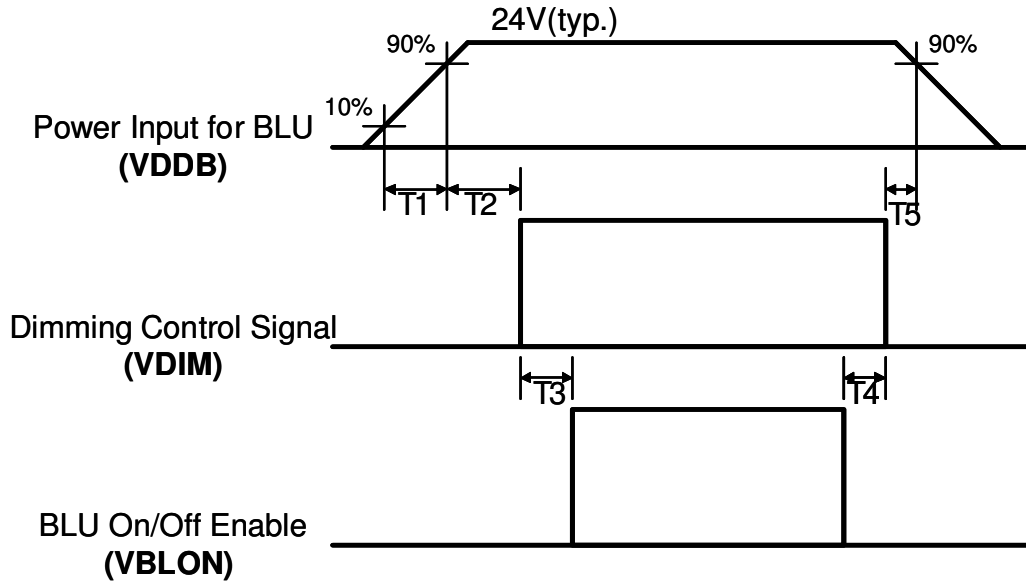

Dip condition for Inverter

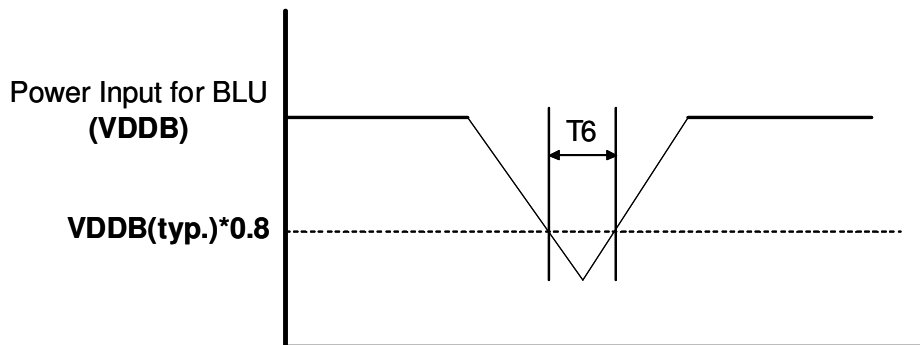

Parameter	Value			Units
	Min	Typ	Max	
T1	20	-	-	ms
T2	500	-	-	ms
T3	250	-	-	ms
T4	0	-	-	ms
T5	1	-	-	ms
T6	-	-	10	ms

4. Optical Specification

Optical characteristics are determined after the unit has been 'ON' and stable for approximately 45 minutes in a dark environment at 25°C. The values specified are at an approximate distance 50cm from the LCD surface at a viewing angle of ϕ and θ equal to 0°.

Fig.1 presents additional information concerning the measurement equipment and method.

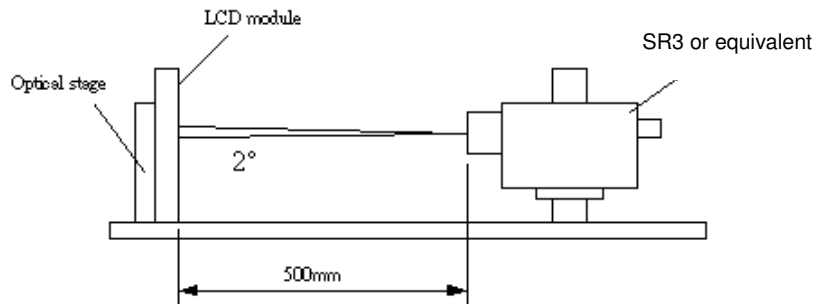

Parameter	Symbol	Values			Unit	Notes
		Min.	Typ.	Max		
Contrast Ratio	CR	4,000	5,000	--		1
Surface Luminance (White)	L _{WH}	360	450	--	cd/m ²	2
Luminance Variation	$\delta_{\text{WHITE}(\theta P)}$	--	--	1.3		3
Response Time (G to G)	T _Y	--	8	--	Ms	4
Color Gamut	NTSC		72		%	
Color Coordinates						
	Red	R _X	Typ.-0.03	0.645	Typ.+0.03	
		R _Y		0.330		
	Green	G _X		0.290		
		G _Y		0.615		
	Blue	B _X		0.145		
		B _Y		0.055		
	White	W _X		0.280		
	W _Y	0.290				
Viewing Angle						
	x axis, right($\phi=0^\circ$)	θ_r	--	89	--	degree
	x axis, left($\phi=180^\circ$)	θ_l	--	89	--	degree
	y axis, up($\phi=90^\circ$)	θ_u	--	89	--	degree
	y axis, down ($\phi=270^\circ$)	θ_d	--	89	--	degree

Note:

1. Contrast Ratio (CR) is defined mathematically as:

$$\text{Contrast Ratio} = \frac{\text{Surface Luminance of } L_{on5}}{\text{Surface Luminance of } L_{off5}}$$

2. Surface luminance is luminance value at point 5 across the LCD surface 50cm from the surface with all pixels displaying white. From more information see FIG 2. When lamp current $I_H = 15.5\text{mA}$. $L_{WH} = L_{on5}$ where L_{on5} is the luminance with all pixels displaying white at center 5 location.

3. The variation in surface luminance, δ_{WHITE} is defined (center of Screen) as:

$$\delta_{WHITE(9P)} = \frac{\text{Maximum}(L_{on1}, L_{on2}, \dots, L_{on9})}{\text{Minimum}(L_{on1}, L_{on2}, \dots, L_{on9})}$$

4. Response time T_γ is the average time required for display transition by switching the input signal for five luminance ratio (0%,25%,50%,75%,100% brightness matrix) and is based on $F_v=60\text{Hz}$ to optimize.

Measured Response Time		Target				
		0%	25%	50%	75%	100%
Start	0%		0% to 25%	0% to 50%	0% to 75%	0% to 100%
	25%	25% to 0%		25% to 50%	25% to 75%	25% to 100%
	50%	50% to 0%	50% to 25%		50% to 75%	50% to 100%
	75%	75% to 0%	75% to 25%	75% to 50%		75% to 100%
	100%	100% to 0%	100% to 25%	100% to 50%	100% to 75%	

4. Viewing angle is the angle at which the contrast ratio is greater than 10. The angles are determined for the horizontal or x axis and the vertical or y axis with respect to the z axis which is normal to the LCD surface. For more information see FIG4.

FIG. 2 Luminance

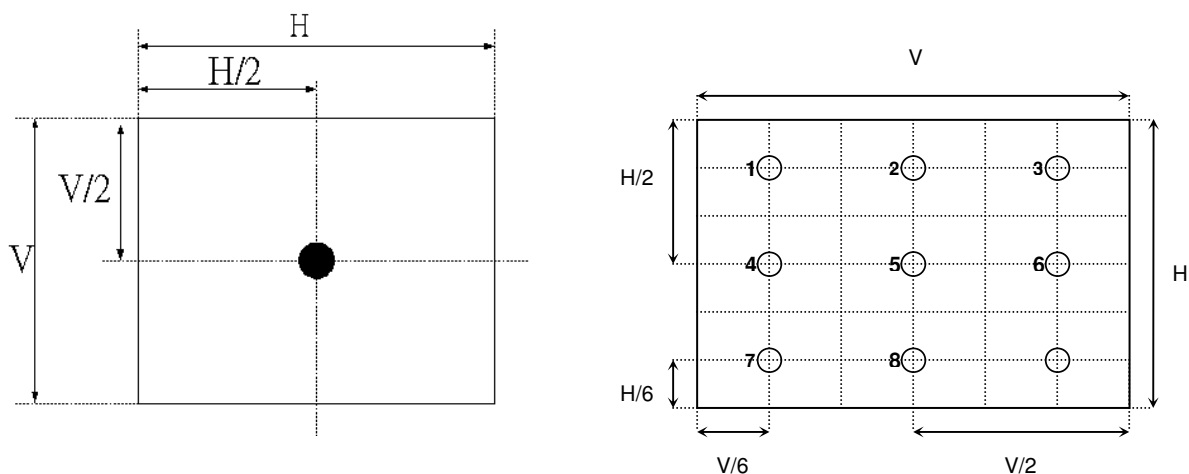

FIG.3 Response Time

The response time is defined as the following figure and shall be measured by switching the input signal for “any level of grey(bright) “ and “any level of gray(dark)”.

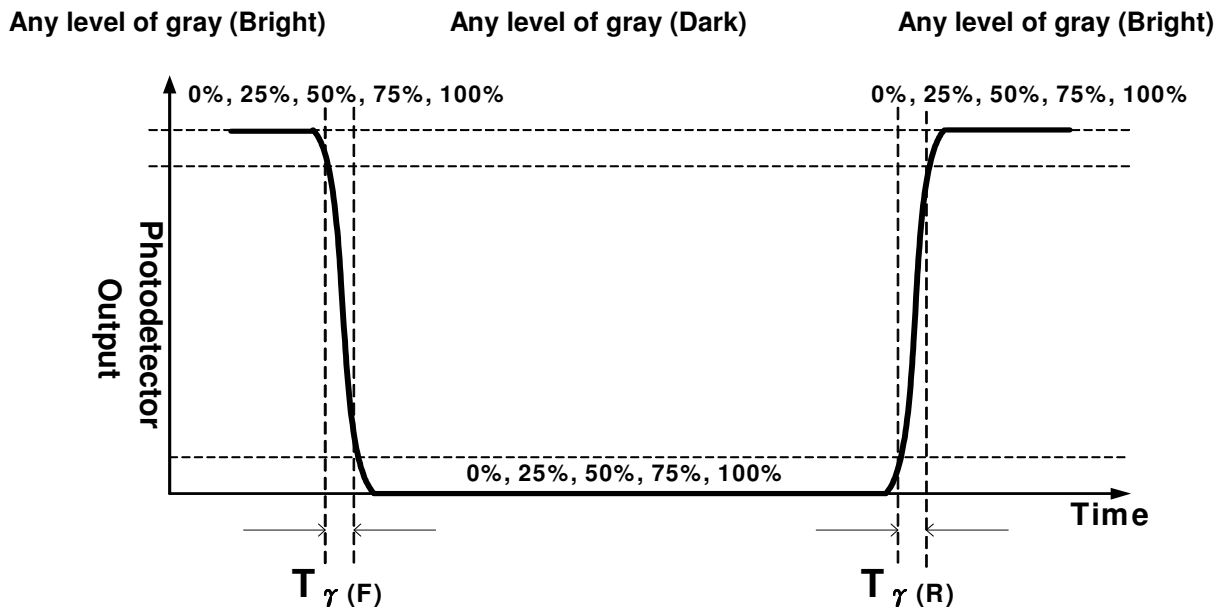
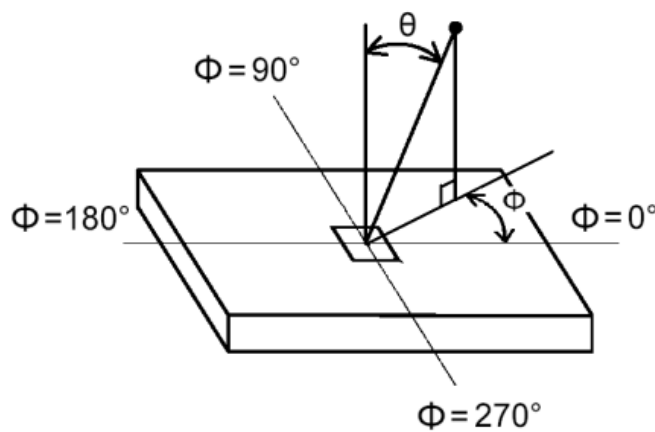

FIG.4 Viewing Angle



5. Mechanical Characteristics

The contents provide general mechanical characteristics for the model T460HW03 VF. In addition the figures in the next page are detailed mechanical drawing of the LCD.

Outline Dimension	Horizontal	1083.0mm
	Vertical	627.0mm
	Depth	59.0mm (w/ inverter & shielding)
Bezel Opening	Horizontal	1024.9 mm
	Vertical	578.6 mm
Active Display Area	Horizontal	1018.08 mm
	Vertical	572.67 mm
Weight	13000 g(Typ.)	
Surface Treatment	AG, Haze=13%, 3H	

Front View

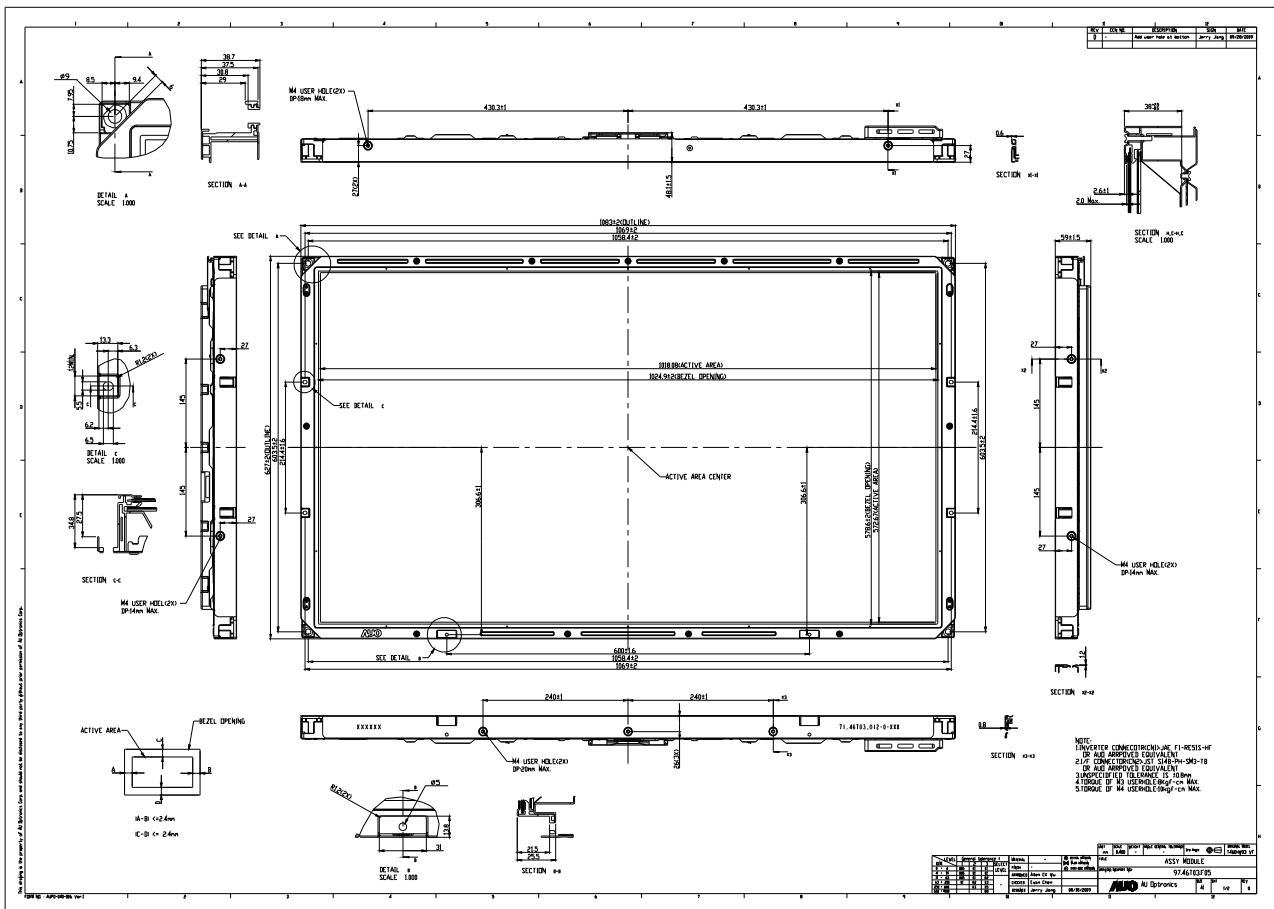

Back View

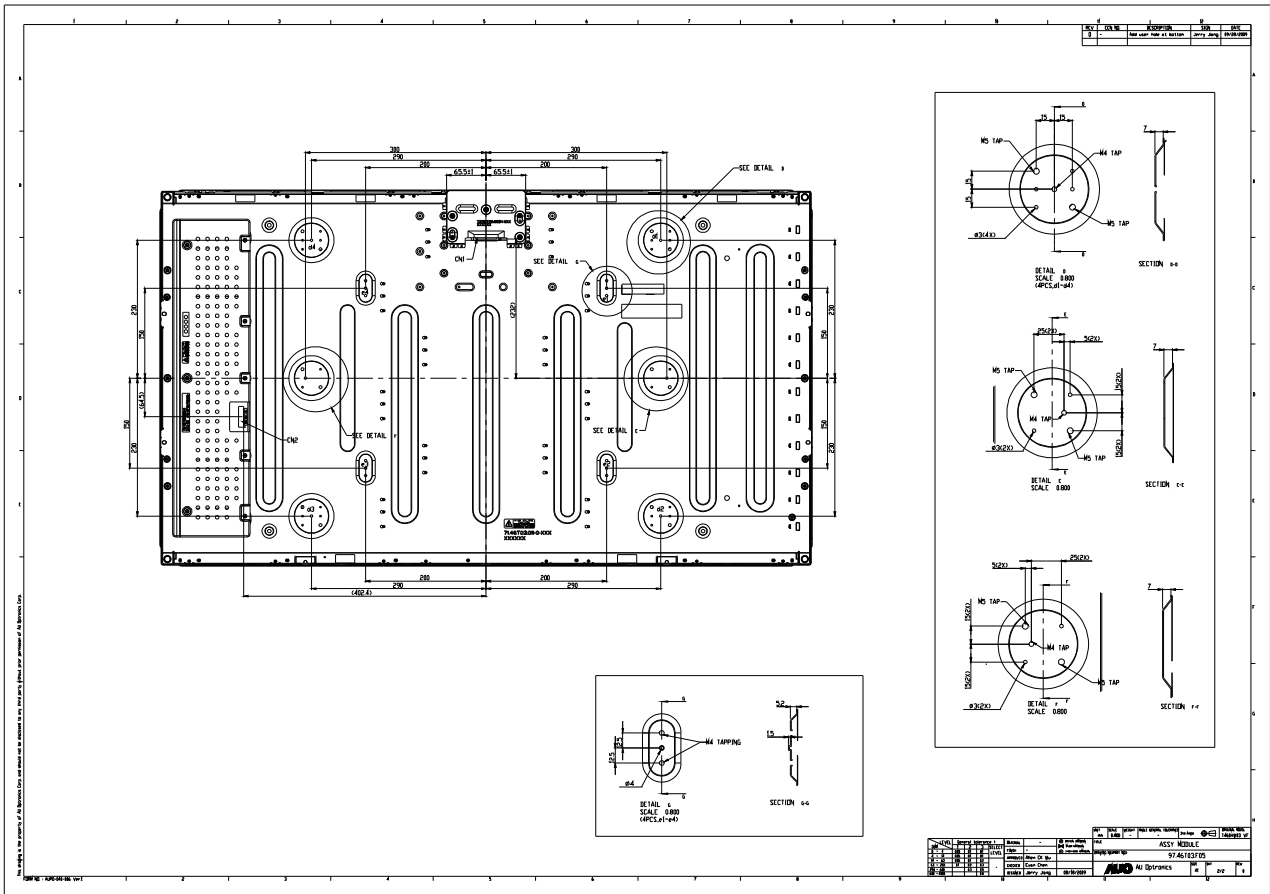

6. Reliability Test Items

	Test Item	Q'ty	Condition
1	High temperature storage test	3	60°C , 300hrs
2	Low temperature storage test	3	-20°C , 300hrs
3	High temperature operation test	3	50°C , 300hrs
4	Low temperature operation test	3	-5°C , 300hrs
5	Vibration test (non-operation)	3	Wave form : random Vibration level : 1.5G RMS Bandwidth: 10-300Hz Duration: X, Y, Z 30min One time for each direction
6	Shock test (non-operation)	3	Shock level: 50G Waveform: half sine wave, 11ms Direction: ±X, ±Y, ±Z, One time each direction
7	Vibration test (With carton)	1(PCK)	Random wave (1.5G RMS, 10-200Hz) 30mins/ Per each X,Y,Z axes
8	Drop test (With carton)	1(PCK)	Drop Height: 25.4 cm, 6 Flats (ASTMD4169-I)

7. International Standard

7.1 Safety

- (1) UL 60950-1, UL 60065; Standard for Safety of Information Technology Equipment Including electrical Business Equipment.
- (2) IEC 60950-1 : 2001, IEC 60065:2001 ; Standard for Safety of International Electrotechnical Commission
- (3) EN 60950 : 2001+A11, EN 60065:2002+A1:2006; European Committee for Electrotechnical Standardization (CENELEC), EUROPEAN STANDARD for Safety of Information Technology Equipment Including Electrical Business Equipment.

7.2 EMC

- (1) ANSI C63.4 “Methods of Measurement of Radio-Noise Emissions from Low-Voltage Electrical and Electrical Equipment in the Range of 9kHz to 40GHz. “American National standards Institute(ANSI), 1992
- (2) C.I.S.P.R “Limits and Methods of Measurement of Radio Interface Characteristics of Information Technology Equipment.” International Special committee on Radio Interference.
- (3) EN 55022 “Limits and Methods of Measurement of Radio Interface Characteristics of Information Technology Equipment.” European Committee for Electrotechnical Standardization. (CENELEC), 1998

8. Packing

8-1 Definition of Label :

A. Panel Label:

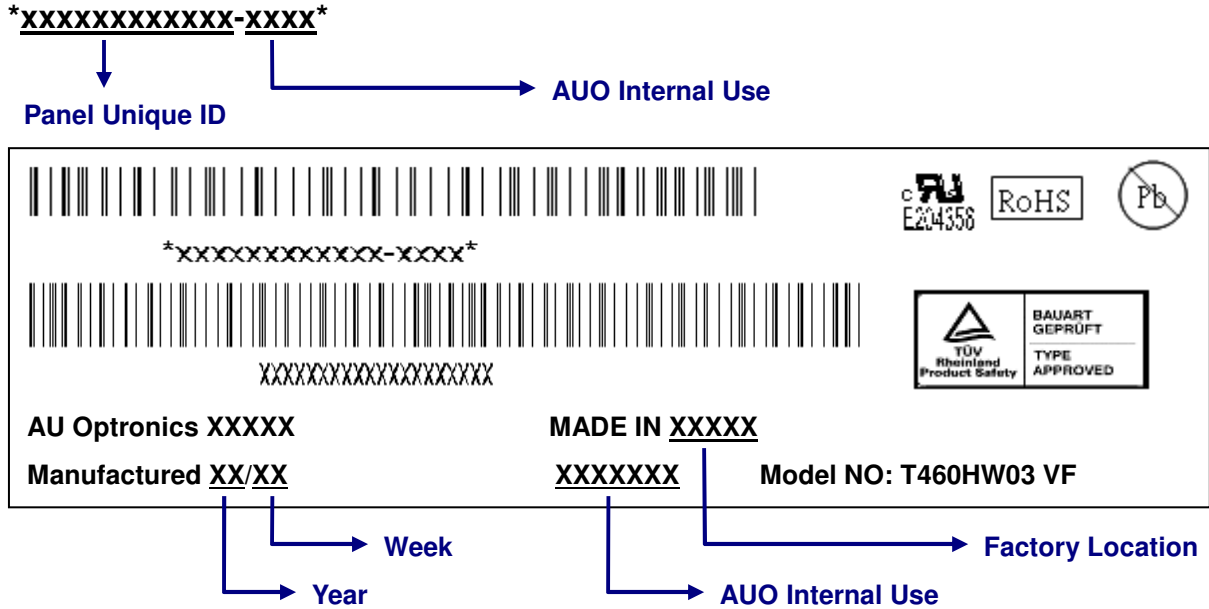

Green mark description

- (1) For Pb Free Product, AUO will add for identification.
- (2) For RoHs compatible products, AUO will add for identification.

Note: The green Mark will be present only when the green documents have been ready by AUO internal green team. (definition of green design follows the AUO green design checklist.)

B. Carton Label:

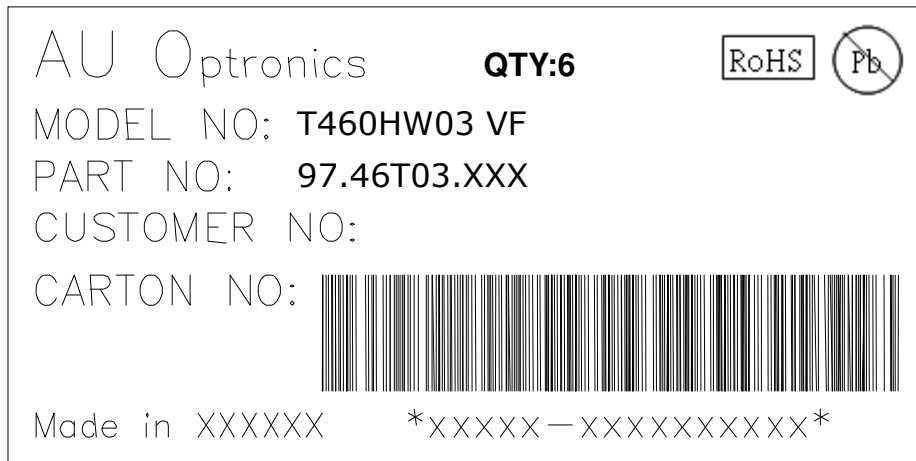

8-2 Packing Methods:

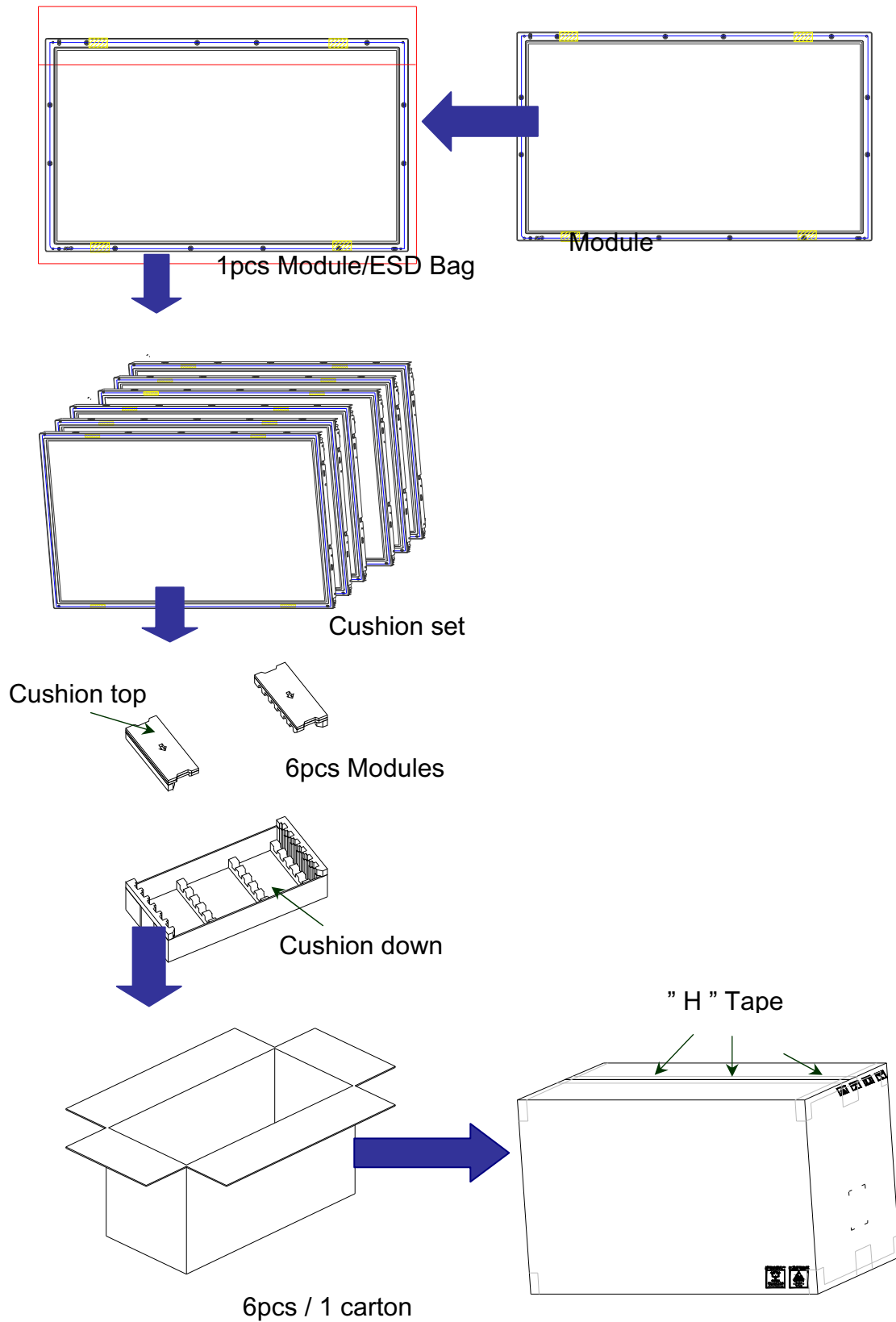

8-3 Pallet and Shipment Information

	Item	Specification			Packing Remark
		Qty.	Dimension	Weight (kg)	
1	Packing Box	6 pcs/box	1160(L)mm*547(W)mm*680(H)mm	97	
2	Pallet	1	1180(L)mm*1150(W)mm*132(H)mm	18	
3	Boxes per Pallet	2 boxes/Pallet (By Air) ; 2 Boxes/Pallet (By Sea)			
4	Panels per Pallet	12pcs/pallet(By Air) ; 12 pcs/Pallet (By Sea)			
5	Pallet after packing	12(by Air)	1180(L)mm*1150(W)mm*812(H)mm (by Air)	212 (by Air)	
		36(by Sea)	1180(L)mm*1150(W)mm*2436(H)mm (by Sea)	636 (by Sea)	40ft HQ

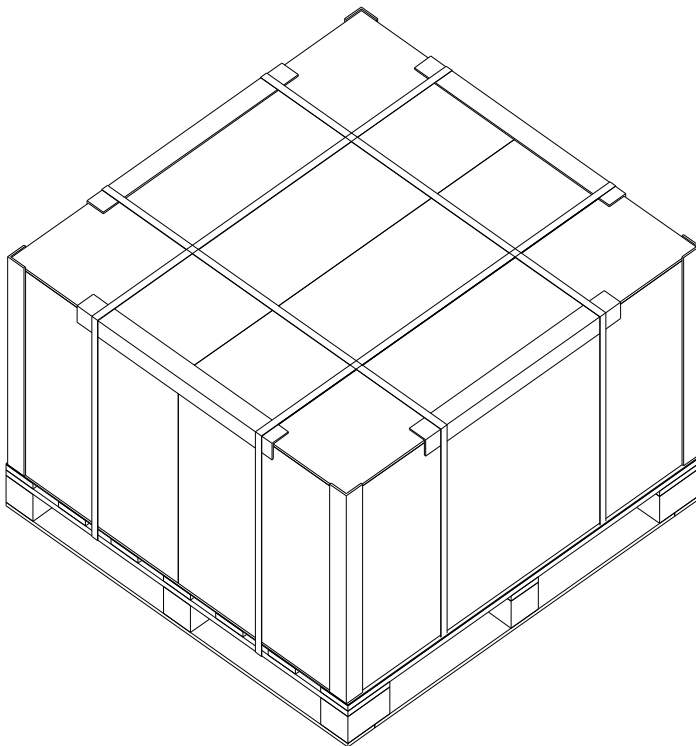

9. PRECAUTIONS

Please pay attention to the followings when you use this TFT LCD module.

9-1 MOUNTING PRECAUTIONS

- (1) You must mount a module using holes arranged in four corners or four sides.
- (2) You should consider the mounting structure so that uneven force (ex. twisted stress) is not applied to module. And the case on which a module is mounted should have sufficient strength so that external force is not transmitted directly to the module.
- (3) Please attach the surface transparent protective plate to the surface in order to protect the polarizer. Transparent protective plate should have sufficient strength in order to resist external force.
- (4) You should adopt radiation structure to satisfy the temperature specification.
- (5) Acetic acid type and chlorine type materials for the cover case are not desirable because the former generates corrosive gas of attacking the polarizer at high temperature and the latter causes circuit broken by electro-chemical reaction.
- (6) Do not touch, push or rub the exposed polarizer with glass, tweezers or anything harder than HB pencil lead. And please do not rub with dust clothes with chemical treatment. Do not touch the surface of polarizer for bare hand or greasy cloth. (Some cosmetics are detrimental to the polarizer.)
- (7) When the surface becomes dusty, please wipe gently with absorbent cotton or other soft materials like chamois soaked with petroleum benzene. Normal-hexane is recommended for cleaning the adhesives used to attach front/ rear polarizer. Do not use acetone, toluene and alcohol because they cause chemical damage to the polarizer.
- (8) Wipe off saliva or water drops as soon as possible. Their long time contact with polarizer causes deformations and color fading.
- (9) Do not open the case because inside circuits do not have sufficient strength.

9-2 OPERATING PRECAUTIONS

- (1) The device listed in the product specification sheets was designed and manufactured for TV application
- (2) The spike noise causes the mis-operation of circuits. It should be lower than following voltage:
 $V = \pm 200\text{mV}$ (Over and under shoot voltage)
- (3) Response time depends on the temperature. (In lower temperature, it becomes longer..)
- (4) Brightness of CCFL depends on the temperature. (In lower temperature, it becomes lower.) And in lower temperature, response time (required time that brightness is stable after turned on) becomes longer.
- (5) Be careful for condensation at sudden temperature change. Condensation makes damage to polarizer or electrical contacted parts. And after fading condensation, smear or spot will occur.
- (6) When fixed patterns are displayed for a long time, remnant image is likely to occur.
- (7) Module has high frequency circuits. Sufficient suppression to the electromagnetic interference shall

be done by system manufacturers. Grounding and shielding methods may be important to minimize the interface.

9-3 ELECTROSTATIC DISCHARGE CONTROL

Since a module is composed of electronic circuits, it is not strong to electrostatic discharge. Make certain that treatment persons are connected to ground through wristband etc. And don't touch interface pin directly.

9-4 PRECAUTIONS FOR STRONG LIGHT EXPOSURE

Strong light exposure causes degradation of polarizer and color filter.

9-5 STORAGE

When storing modules as spares for a long time, the following precautions are necessary.

- (1) Store them in a dark place. Do not expose the module to sunlight or fluorescent light. Keep the temperature between 5°C and 35°C at normal humidity.
- (2) The polarizer surface should not come in contact with any other object. It is recommended that they be stored in the container in which they were shipped.

9-6 HANDLING PRECAUTIONS FOR PROTECTION FILM

- (1) The protection film is attached to the bezel with a small masking tape. When the protection film is peeled off, static electricity is generated between the film and polarizer. This should be peeled off slowly and carefully by people who are electrically grounded and with well ion-blown equipment or in such a condition, etc.
- (2) When the module with protection film attached is stored for a long time, sometimes there remains a very small amount of glue still on the bezel after the protection film is peeled off.
- (3) You can remove the glue easily. When the glue remains on the bezel or its vestige is recognized, please wipe them off with absorbent cotton waste or other soft material like chamois soaked with normal-hexane.