

**SHARP**

|      |                  |
|------|------------------|
| No.  | <b>LD -15163</b> |
| DATE | Feb. 19 . 2003   |

TECHNICAL LITERATURE  
FOR  
TFT - LCD module

MODEL No. LQ121S1DG41

The technical literature is subject to change without notice.  
So, please contact Sharp or its representative before designing  
your product based on this literature.

DEVELOPMENT ENGINEERING DEPT.  
AVC LIQUID CRYSTAL DISPLAY DIVISION  
AVC LIQUID CRYSTAL DISPLAY GROUP  
SHARP CORPORATION

These specification sheets are the proprietary product of SHARP CORPORATION ("SHARP") and include materials protected under copyright of SHARP. Do not reproduce or cause any third party to reproduce them in any form or by any means, electronic or mechanical, for any purpose in whole or in part, without the express written permission of SHARP.

The device listed in these specification sheets was designed and manufactured for use in general electronic equipment.

In case of using the device for applications such as control and safety equipment for transportation(aircraft, trains, automobiles, etc.),rescue and security equipment and various safety related equipment which require higher reliability and safety, take into consideration that appropriate measures such as fail-safe functions and redundant system design should be taken.

Do not use the device for equipment that requires an extreme level of reliability, such as aerospace applications, telecommunication equipment(trunk lines), nuclear power control equipment and medical or other equipment for life support.

SHARP assumes no responsibility for any damage resulting from the use of the device which does not comply with the instructions and the precautions specified in these specification sheets.

Contact and consult with a SHARP sales representative for any questions about this device.

### 1. Application

This specification applies to color TFT-LCD module, LQ121S1DG41.

### 2. Overview

This module is a color active matrix LCD module incorporating amorphous silicon TFT (Thin Film Transistor). It is composed of a color TFT-LCD panel, driver ICs, control circuit and power supply circuit and a backlight unit. Graphics and texts can be displayed on a  $800 \times 3 \times 600$  dots panel with 262,144 colors by supplying 18 bit data signal (6bit/color), four timing signals, +3.3V/5.0V DC supply voltage for TFT-LCD panel driving and supply voltage for backlight.

The TFT-LCD panel used for this module is a low-reflection and higher-color-saturation type.

Therefore, this module is also suitable for the multimedia use. Viewing angle is 6 o'clock direction.

This module is the type of wide viewing angle and high brightness( $350\text{cd/m}^2$ ).

Backlight-driving DC/AC inverter is not built in this module.

### 3. Mechanical technical literature.

| Parameter                  | Specifications                  | Unit  |
|----------------------------|---------------------------------|-------|
| Display size               | 31 (12.1") Diagonal             | cm    |
| Active area                | 246.0(H) × 184.5(V)             | mm    |
| Pixel format               | 800(H) × 600(V)                 | pixel |
|                            | (1 pixel = R + G + B dots)      | -     |
| Pixel pitch                | 0.3075(H) × 0.3075(V)           | mm    |
| Pixel configuration        | R,G,B vertical stripe           | -     |
| Display mode               | Normally white                  | -     |
| Unit outline dimensions *1 | 276.0(W) × 209.0(H) × (11.0)(D) | mm    |
| Mass                       | MAX.(T.B.D)                     | g     |
| Surface treatment          | Anti-glare and hard-coating 3H  | -     |

\*1.Note: excluding backlight cables.

Outline dimensions is shown in Fig.1

## 4. Input Terminals

## 4-1. TFT-LCD panel driving

## CN1

Corresponding connector: DF9-41S-1V,DF9A-41S-1V,DF9B-41S-1V,DF9M-41S-1V

| Pin No. | Symbol | Function   | Remark  |
|---------|--------|--|---------|
| 1       | GND    | -  | -       |
| 2       | CK     | Clock signal for sampling each data signal       | -       |
| 3       | GND    | -  | -       |
| 4       | Hsync  | Horizontal synchronous signal                    | [Note1] |
| 5       | Vsync  | Vertical synchronous signal                      | [Note1] |
| 6       | GND    | -  | -       |
| 7       | GND    | -  | -       |
| 8       | GND    | -  | -       |
| 9       | R0     | R E D data signal(LSB )                          | -       |
| 10      | R1     | R E D data signal                                | -       |
| 11      | R2     | R E D data signal                                | -       |
| 12      | GND    | -  | -       |
| 13      | R3     | R E D data signal                                | -       |
| 14      | R4     | R E D data signal                                | -       |
| 15      | R5     | R E D data signal(MSB)                           | -       |
| 16      | GND    | -  | -       |
| 17      | GND    | -  | -       |
| 18      | GND    | -  | -       |
| 19      | G0     | G R E E N data signal(LSB)                       | -       |
| 20      | G1     | G R E E N data signal                            | -       |
| 21      | G2     | G R E E N data signal                            | -       |
| 22      | GND    | -  | -       |
| 23      | G3     | G R E E N data signal                            | -       |
| 24      | G4     | G R E E N data signal                            | -       |
| 25      | G5     | G R E E N data signal(MSB)                       | -       |
| 26      | GND    | -  | -       |
| 27      | GND    | -  | -       |
| 28      | GND    | -  | -       |
| 29      | B0     | B L U E data signal(LSB)                         | -       |
| 30      | B1     | B L U E data signal                              | -       |
| 31      | B2     | B L U E data signal                              | -       |
| 32      | GND    | -  | -       |
| 33      | B3     | B L U E data signal                              | -       |
| 34      | B4     | B L U E data signal                              | -       |
| 35      | B5     | B L U E data signal(MSB)                         | -       |
| 36      | GND    | -  | -       |
| 37      | ENAB   | Signal to settle the horizontal display position | [Note2] |
| 38      | R/L    | Horizontal display mode select signal            | [Note3] |
| 39      | Vcc    | power supply                                     | -       |
| 40      | Vcc    | power supply                                     | -       |
| 41      | U/D    | Vertical display mode select signal              | [Note4] |

The shielding case is connected with GND.

[Note1] The polarity of both synchronous signals are negative.

[Note2] The horizontal display start timing is settled in accordance with a rising timing of ENAB signal. In case ENAB is fixed "Low", the horizontal start timing is determined as described in 7-2. Don't keep ENAB "High" during operation.

[Note 3],[Note 4]

R/L = High, U/D = Low

R/L = Low, U/D = Low

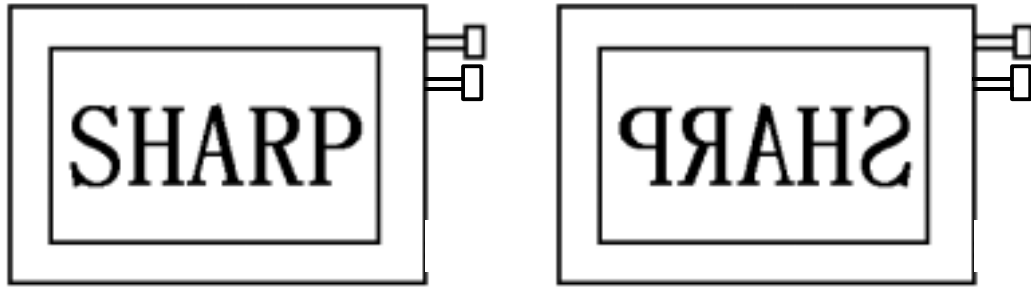

R/L = High, U/D = Low

R/L = Low, U/D = Low

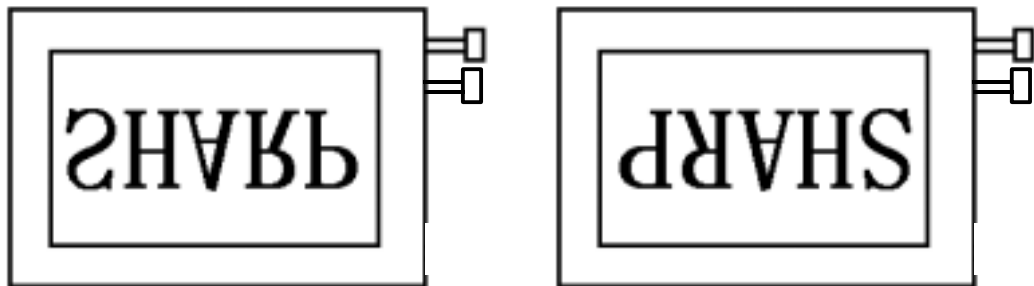

4-2. Backlight driving

Used connector : BHR-03VS-1(JST)

CN 2 , CN3

Corresponding connector :SM02(8.0)B-BHS(JST)

| Pin no. | symbol            | function                                  |
|---------|-------------------|---|
| 1       | V <sub>HIGH</sub> | Power supply for lamp (High voltage side) |
| 2       | NC                | This is electrically opened.              |
| 3       | V <sub>LOW</sub>  | Power supply for lamp (Low voltage side)  |

5. Absolute Maximum Ratings

| Parameter                       | Symbol           | Condition | Ratings                      | Unit | Remark  |
|---------------------------------|------------------|-----------|------------------------------|------|---------|
| Input voltage                   | V <sub>I</sub>   | Ta=25     | -0.3 to V <sub>CC</sub> +0.3 | V    | [Note1] |
| supply voltage                  | V <sub>CC</sub>  | Ta=25     | 0 to +6.0                    | V    | -       |
| Storage temperature             | T <sub>stg</sub> | -         | -30 to +(70)                 |      | [Note2] |
| Operating temperature (Ambient) | T <sub>opa</sub> | -         | -10 to +65                   |      |         |

[Note1]CK,R0 ~ R5,G0 ~ G5,B0 ~ B5,Hsync,Vsync,ENAB

[Note2]Humidity : 95%RH Max. at Ta 40 .

Maximum wet-bulb temperature at 39 or less at Ta>40 .

No condensation.

6. Electrical Characteristics

6-1. TFT-LCD panel driving

Ta = 25

| Parameter                       |                     | Symbol           | Min.   | Typ.          | Max.   | Unit  | Remark                      |
|---------------------------------|---------------------|------------------|--------|---------------|--------|-------|-----------------------------|
| Power Supply                    | Supply voltage      | Vcc              | +3.0   | +3.3/<br>+5.0 | +5.5   | V     | [Note1]                     |
|                                 | Current dissipation | Icc              | -      | T.B.D         | T.B.D  | mA    | Vcc=3.3V<br>[Note2]         |
|                                 |                     | Icc              | -      | T.B.D         | T.B.D  | mA    | Vcc=5.0V<br>[Note2]         |
| Permissive input ripple voltage |                     | V <sub>RF</sub>  | -      | -             | 100    | mVp-p |                             |
| Input voltage (Low)             |                     | V <sub>IL</sub>  | -      | -             | 0.3Vcc | V     | [Note3]                     |
| Input voltage (High)            |                     | V <sub>IH</sub>  | 0.7Vcc | -             | -      | V     |                             |
| Input current (low)             |                     | I <sub>OL1</sub> | -      | -             | 1.0    | μ A   | V <sub>I</sub> =0V [Note4]  |
|                                 |                     | I <sub>OL2</sub> |        |               | 10     | μ A   | V <sub>I</sub> =0V [Note5]  |
|                                 |                     | I <sub>OL3</sub> | -      | -             | 800    | μ A   | V <sub>I</sub> =0V [Note6]  |
| Input current (High)            |                     | I <sub>OH1</sub> | -      | -             | 1.0    | μ A   | V <sub>I</sub> =Vcc [Note7] |
|                                 |                     | I <sub>OH2</sub> |        |               | 300    | μ A   | V <sub>I</sub> =Vcc [Note8] |
|                                 |                     | I <sub>OH3</sub> | -      | -             | 800    | μ A   | V <sub>I</sub> =Vcc [Note9] |

[Note1]

Vcc-turn-on conditions

- 0 < t1 15ms
- 0 < t2 10ms
- 0 < t3 100ms
- 0 < t4 1s
- t5 > 200ms

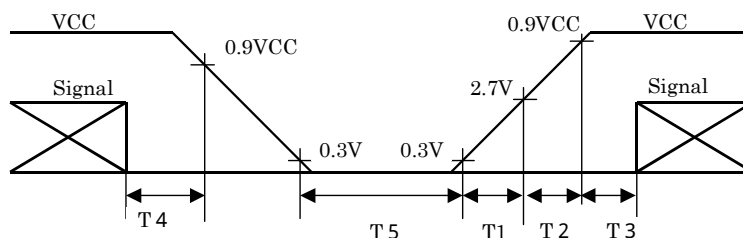

Vcc-dip conditions

- 1) 2.5V Vcc
- td 10ms
- 2) Vcc < 2.5V

Vcc-dip conditions should also follow the Vcc-turn-on conditions

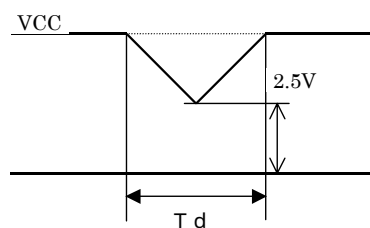

[Note2] Typical current situation : 16-gray-bar pattern.

480 line mode/Vcc=+3.3V/ + 5.0V

[Note3] CK,R0~R5,G0~G5,B0~B5,Hsync,Vsync,ENAB,  
R/L,U/D

[Note4] CK,R0~R5,G0~G5,B0~B5,Hsync,Vsync,

[Note5] U/D,ENAB

[Note6] R/L

[Note7] CK,R0~R5,G0~G5,B0~B5,Hsnc,Vsync,R/L

[Note8] ENAB

[Note9] U/D

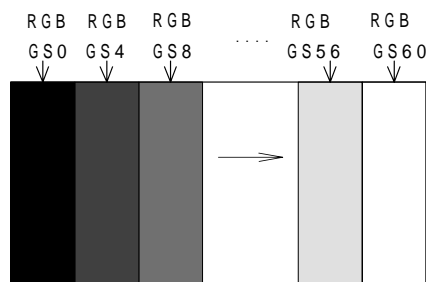

## 6-2. Backlight driving

The backlight system is an edge-lighting type with double CCFT (Cold Cathode Fluorescent Tube).

The characteristics of single lamp are shown in the following table.

| Parameter              | Symbol | Min.  | Typ.  | Max.    | Unit   | Remark            |
|------------------------|--------|-------|-------|---------|--------|-------------------|
| Lamp current           | $I_L$  | (3.0) | 5.5   | 6.0     | mA rms | [Note1]           |
| Lamp power consumption | $P_L$  | -     | (3.3) | -       | W      | [Note2]           |
| Lamp frequency         | $F_L$  | 35    | 60    | 80      | KHz    | [Note3]           |
| Kick-off voltage       | $V_s$  | -     | -     | (1200)  | V rms  | $T_a=25$ [Note4]  |
|                        |        | -     | -     | (1400)  | V rms  | $T_a=0$ [Note4]   |
|                        |        | -     | -     | (T.B.D) | V rms  | $T_a=-10$ [Note4] |
| Lamp life time         | $L_L$  | 50000 | -     | -       | Hour   | [Note5]           |

[Note1] Lamp current is measured with current meter for high frequency as shown below.

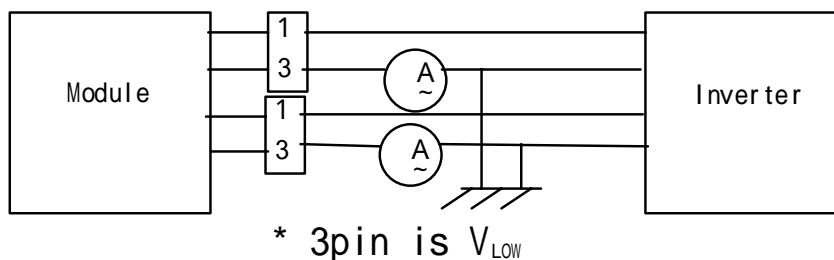

[Note2] At the condition of  $I_L=5.5\text{mA rms}$ .

[Note3] Lamp frequency may produce interference with horizontal synchronous frequency, and this may cause beat on the display. Therefore lamp frequency shall be detached as much as possible from the horizontal synchronous frequency and from the harmonics of horizontal synchronous to avoid interference.

[Note4] The open output voltage of the inverter shall be maintained for more than 1s; otherwise the lamp may not be turned on.

[Note5] Since lamp is consumables, the life time written above is referential value and it is not guaranteed in this specification sheet by SHARP.

Lamp life time is defined that it applied either or under this condition  
(Continuous turning on at  $T_a=25$ ,  $I_L=6.0\text{mA rms}$ )

Brightness becomes 50% of the original value under standard condition.

Kick-off voltage at  $T_a=-10$  exceeds maximum value, (1500V) rms.

In case of operating under lower temp environment, the lamp exhaustion is accelerated and the brightness becomes lower.

(Continuous operating for around 1 month under lower temp condition may reduce the brightness to half of the original brightness.)

In case of such usage under lower temp environment, periodical lamp exchange is recommended.

[Note6] The performance of the backlight, for example life time or brightness, is much influenced by the characteristics of the DC-AC inverter for the lamp. When you design or order the inverter, please make sure that a poor lighting caused by the mismatch of the backlight and the inverter (miss-lighting, flicker, etc.) never occur. when you confirm it, the module should be operated in the same condition as it is installed in your instrument.

Be sure to use a back light power supply with the safety protection circuit such as the detection circuit for the excess voltage, excess current and or electric discharge waveform.

Be sure to use the detect circuit by which one side of the CCFT lamps can be controlled independently. Otherwise, when one side of the CCFT is open, the excess current may possibly be applied to the other side of the lamp.

[Note7] It is required to have the inverter designed so that to allow the impedance deviation of the two CCFT lamps and the capacity deviation of barast capacitor.

## 7. Timing Characteristics of input signals

Timing diagrams of input signal are shown in Fig.2.

### 7-1. Timing characteristics

| Parameter                    |             | Symbol | Min. | Typ. | Max.   | Unit    | Remark |
|------------------------------|-------------|--------|------|------|--------|---------|--------|
| Clock                        | Frequency   | 1/Tc   | 35   | 40.0 | 42.0   | MHz     | -      |
|                              | High time   | Tch    | 6    | -    | -      | ns      | -      |
|                              | Low time    | Tcl    | 6    | -    | -      | ns      | -      |
|                              | Duty ratio  | Th/T   | 40   | 50   | 60     | %       | -      |
| Data                         | Setup time  | Tds    | 3    | -    | -      | ns      | -      |
|                              | Hold time   | Tdh    | 5    | -    | -      | ns      | -      |
| Horizontal sync. signal      | Cycle       | TH     | 20.8 | 26.4 | 39.9   | $\mu$ s | -      |
|                              |             |        | 832  | 1056 | 1395   | clock   | -      |
|                              | Pulse width | THp    | 2    | 128  | 200    | clock   | -      |
| Vertical sync. signal        | Cycle       | TV     | 628  | 666  | 798    | line    | -      |
|                              | Pulse width | TVp    | 2    | 4    | 6      | line    | -      |
| Horizontal display period    |             | THd    | 800  | 800  | 800    | clock   | -      |
| Hsync-Clock phase difference |             | THc    | 0    | -    | Tc-10  | ns      | -      |
| Hsync-Vsync phase difference |             | TVh    | 0    | -    | TH-THp | ns      | -      |
| Vertical data start position |             | TVs    | 23   | 23   | 23     | line    | -      |

Note) In case of lower frequency, the deterioration of display quality, flicker etc., may be occurred.

### 7-2. Horizontal display position

The horizontal display position is determined by ENAB signal and the input data corresponding to the rising edge of ENAB signal is displayed at the left end of the active area.

| Parameter                            |             | symbol | Min. | Typ. | Max.       | Unit  | Remark |
|--------------------------------------|-------------|--------|------|------|------------|-------|--------|
| Enable signal                        | Setup time  | Tes    | 5    | -    | Tc-10      | ns    | -      |
|                                      | Pulse width | Tep    | 2    | 800  | TH-10      | clock | -      |
| Hsync-Enable signal phase difference |             | THE    | 0    | -    | TH-TVp-800 | clock | -      |

Note) When ENAB is fixed "Low", the display starts from the data of C88(clock) as shown in Fig.2.

### 7-3. Vertical display position

The vertical display position, TVs is fixed "23" (line).

### 7-4. Input Data Signals and Display Position on the screen

Display position of input data

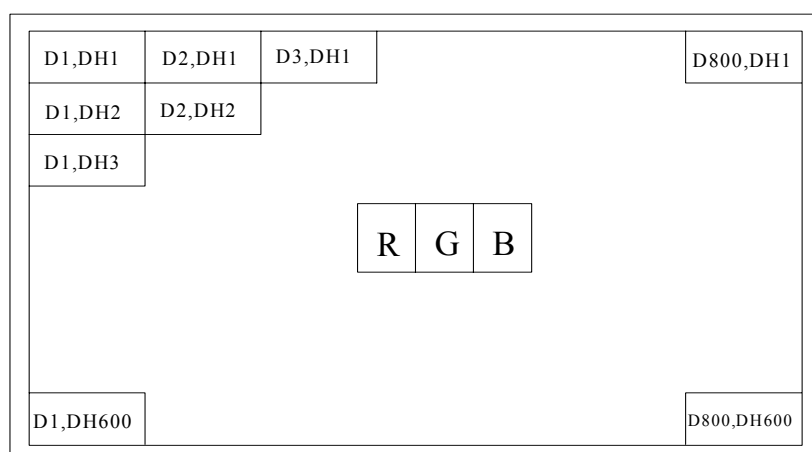

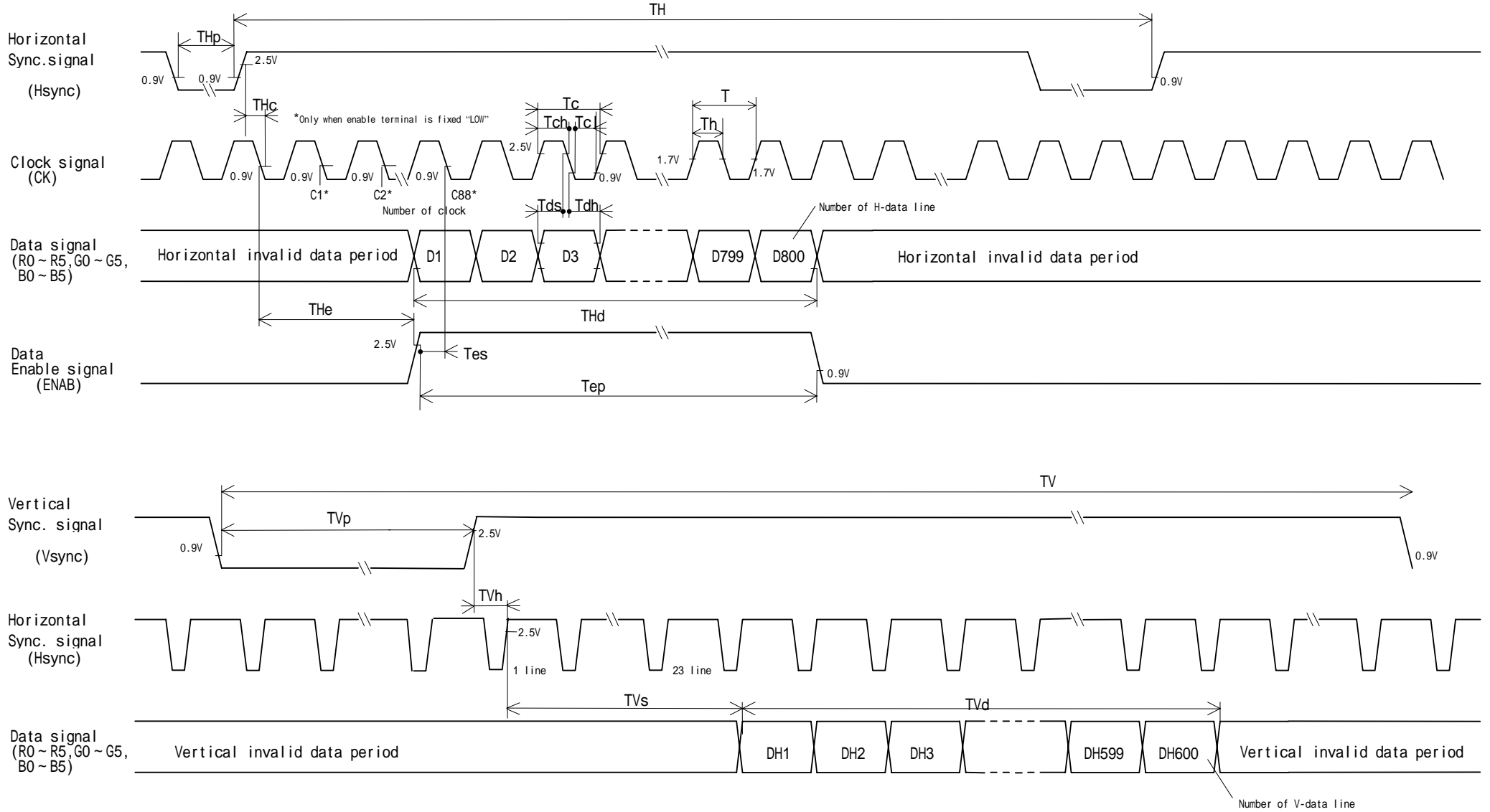

Fig. 2 Input signal waveforms

## 8. Input Signals, Basic Display Colors and Gray Scale of Each Color

|                     | Colors &   | Data signal |    |    |    |    |    |    |    |    |    |    |    |    |    |    |    |    |    |    |
|---------------------|------------|-------------|----|----|----|----|----|----|----|----|----|----|----|----|----|----|----|----|----|----|
|                     | Gray scale | Gray Scale  | R0 | R1 | R2 | R3 | R4 | R5 | G0 | G1 | G2 | G3 | G4 | G5 | B0 | B1 | B2 | B3 | B4 | B5 |
| Basic Color         | Black      | -           | 0  | 0  | 0  | 0  | 0  | 0  | 0  | 0  | 0  | 0  | 0  | 0  | 0  | 0  | 0  | 0  | 0  | 0  |
|                     | Blue       | -           | 0  | 0  | 0  | 0  | 0  | 0  | 0  | 0  | 0  | 0  | 0  | 0  | 1  | 1  | 1  | 1  | 1  | 1  |
|                     | Green      | -           | 0  | 0  | 0  | 0  | 0  | 0  | 1  | 1  | 1  | 1  | 1  | 1  | 0  | 0  | 0  | 0  | 0  | 0  |
|                     | Cyan       | -           | 0  | 0  | 0  | 0  | 0  | 0  | 1  | 1  | 1  | 1  | 1  | 1  | 1  | 1  | 1  | 1  | 1  | 1  |
|                     | Red        | -           | 1  | 1  | 1  | 1  | 1  | 1  | 0  | 0  | 0  | 0  | 0  | 0  | 0  | 0  | 0  | 0  | 0  | 0  |
|                     | Magenta    | -           | 1  | 1  | 1  | 1  | 1  | 1  | 0  | 0  | 0  | 0  | 0  | 0  | 1  | 1  | 1  | 1  | 1  | 1  |
|                     | Yellow     | -           | 1  | 1  | 1  | 1  | 1  | 1  | 1  | 1  | 1  | 1  | 1  | 1  | 0  | 0  | 0  | 0  | 0  | 0  |
|                     | White      | -           | 1  | 1  | 1  | 1  | 1  | 1  | 1  | 1  | 1  | 1  | 1  | 1  | 1  | 1  | 1  | 1  | 1  | 1  |
| Gray Scale of Red   | Black      | GS0         | 0  | 0  | 0  | 0  | 0  | 0  | 0  | 0  | 0  | 0  | 0  | 0  | 0  | 0  | 0  | 0  | 0  | 0  |
|                     | ↑          | GS1         | 1  | 0  | 0  | 0  | 0  | 0  | 0  | 0  | 0  | 0  | 0  | 0  | 0  | 0  | 0  | 0  | 0  | 0  |
|                     | Darker     | GS2         | 0  | 1  | 0  | 0  | 0  | 0  | 0  | 0  | 0  | 0  | 0  | 0  | 0  | 0  | 0  | 0  | 0  | 0  |
|                     | ↑          | ↓           |    |    | ↓  |    |    |    |    | ↓  |    |    |    |    | ↓  |    |    |    |    |    |
|                     | ↓          | ↓           |    |    | ↓  |    |    |    |    | ↓  |    |    |    |    | ↓  |    |    |    |    |    |
|                     | Brighter   | GS61        | 1  | 0  | 1  | 1  | 1  | 1  | 0  | 0  | 0  | 0  | 0  | 0  | 0  | 0  | 0  | 0  | 0  | 0  |
|                     | ↓          | GS62        | 0  | 1  | 1  | 1  | 1  | 1  | 0  | 0  | 0  | 0  | 0  | 0  | 0  | 0  | 0  | 0  | 0  | 0  |
|                     | Red        | GS63        | 1  | 1  | 1  | 1  | 1  | 1  | 0  | 0  | 0  | 0  | 0  | 0  | 0  | 0  | 0  | 0  | 0  | 0  |
| Gray Scale of Green | Black      | GS0         | 0  | 0  | 0  | 0  | 0  | 0  | 0  | 0  | 0  | 0  | 0  | 0  | 0  | 0  | 0  | 0  | 0  | 0  |
|                     | ↑          | GS1         | 0  | 0  | 0  | 0  | 0  | 0  | 1  | 0  | 0  | 0  | 0  | 0  | 0  | 0  | 0  | 0  | 0  | 0  |
|                     | Darker     | GS2         | 0  | 0  | 0  | 0  | 0  | 0  | 0  | 1  | 0  | 0  | 0  | 0  | 0  | 0  | 0  | 0  | 0  | 0  |
|                     | ↑          | ↓           |    |    | ↓  |    |    |    |    | ↓  |    |    |    |    | ↓  |    |    |    |    |    |
|                     | ↓          | ↓           |    |    | ↓  |    |    |    |    | ↓  |    |    |    |    | ↓  |    |    |    |    |    |
|                     | Brighter   | GS61        | 0  | 0  | 0  | 0  | 0  | 0  | 1  | 0  | 1  | 1  | 1  | 1  | 0  | 0  | 0  | 0  | 0  | 0  |
|                     | ↓          | GS62        | 0  | 0  | 0  | 0  | 0  | 0  | 0  | 1  | 1  | 1  | 1  | 1  | 0  | 0  | 0  | 0  | 0  | 0  |
|                     | Green      | GS63        | 0  | 0  | 0  | 0  | 0  | 0  | 1  | 1  | 1  | 1  | 1  | 1  | 0  | 0  | 0  | 0  | 0  | 0  |
| Gray Scale of Blue  | Black      | GS0         | 0  | 0  | 0  | 0  | 0  | 0  | 0  | 0  | 0  | 0  | 0  | 0  | 0  | 0  | 0  | 0  | 0  | 0  |
|                     | ↑          | GS1         | 0  | 0  | 0  | 0  | 0  | 0  | 0  | 0  | 0  | 0  | 0  | 0  | 1  | 0  | 0  | 0  | 0  | 0  |
|                     | Darker     | GS2         | 0  | 0  | 0  | 0  | 0  | 0  | 0  | 0  | 0  | 0  | 0  | 0  | 0  | 1  | 0  | 0  | 0  | 0  |
|                     | ↑          | ↓           |    |    | ↓  |    |    |    |    | ↓  |    |    |    |    | ↓  |    |    |    |    |    |
|                     | ↓          | ↓           |    |    | ↓  |    |    |    |    | ↓  |    |    |    |    | ↓  |    |    |    |    |    |
|                     | Brighter   | GS61        | 0  | 0  | 0  | 0  | 0  | 0  | 0  | 0  | 0  | 0  | 0  | 0  | 1  | 0  | 1  | 1  | 1  | 1  |
|                     | ↓          | GS62        | 0  | 0  | 0  | 0  | 0  | 0  | 0  | 0  | 0  | 0  | 0  | 0  | 0  | 1  | 1  | 1  | 1  | 1  |
|                     | Blue       | GS63        | 0  | 0  | 0  | 0  | 0  | 0  | 0  | 0  | 0  | 0  | 0  | 0  | 1  | 1  | 1  | 1  | 1  | 1  |

0 :Low level voltage, 1 : High level voltage

Each basic color can be displayed in 64 gray scales from 6 bit data signals. According to the combination of total 18 bit data signals, the 262,144-color display can be achieved on the screen.

9. Optical Characteristics

Ta=25 , Vcc=+3.3V / +5.0V

| Parameter             |            | Symbol          | Condition             | Min.  | Typ.  | Max. | Unit              | Remark                               |
|-----------------------|------------|-----------------|-----------------------|-------|-------|------|-------------------|--------------------------------------|
| Viewing angle range   | Horizontal | θ21,θ22         | CR>10                 | T.B.D | 70    | -    | Deg.              | [Note1,4]                            |
|                       | Vertical   | θ11             |                       | T.B.D | 50    | -    | Deg.              |                                      |
|                       |            | θ12             |                       | T.B.D | 60    | -    | Deg.              |                                      |
| Contrast ratio        |            | CRn             | θ=0°                  | 150   | -     | -    |                   | [Note2,4]                            |
|                       |            | CRo             | Optimum viewing angle | -     | 300   | -    |                   |                                      |
| Response time         | Rise       | τ               | θ=0°                  | -     | 20    | -    | ms                | [Note3,4]                            |
|                       | Decay      | τd              |                       | -     | 40    | -    | ms                |                                      |
| Chromaticity of white |            | x               | θ=0°                  | -     | 0.313 | -    |                   | [Note4]                              |
|                       |            | y               |                       | -     | 0.329 | -    |                   | I <sub>L</sub> =6.0mA <sub>rms</sub> |
| Luminance of white    |            | Y <sub>L1</sub> |                       | T.B.D | (350) | -    | cd/m <sup>2</sup> | f=60kHz                              |
| White Uniformity      |            | w               |                       | -     | -     | 1.45 |                   | [Note5]                              |

The measurement shall be executed 30 minutes after lighting at rating. (condition:I<sub>L</sub>=6.0mA rms)

The optical characteristics shall be measured in a dark room or equivalent state with the method shown in Fig.3 below.

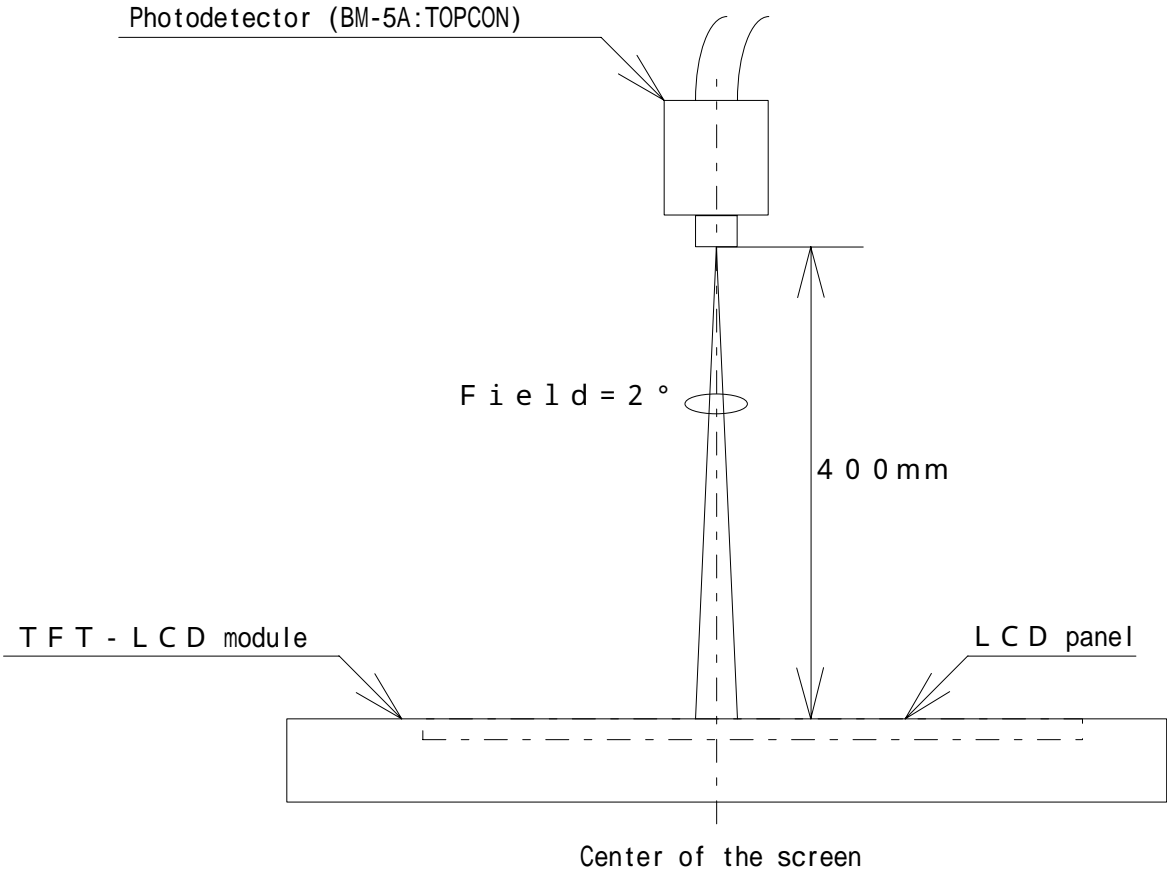
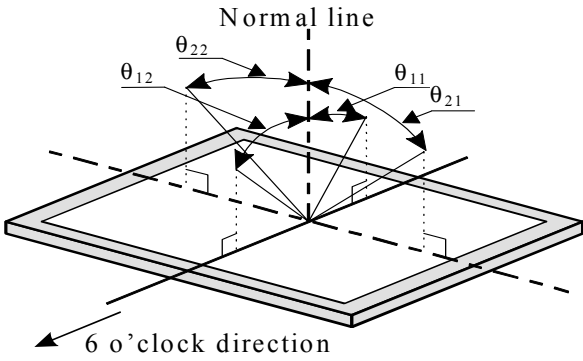

Fig.3 Optical characteristics measurement method

[Note1] Definitions of viewing angle range:



[Note2] Definition of contrast ratio:

The contrast ratio is defined as the following.

$$\text{Contrast Ratio (CR)} = \frac{\text{Luminance (brightness) with all pixels white}}{\text{Luminance (brightness) with all pixels black}}$$

[Note3] Definition of response time:

The response time is defined as the following figure and shall be measured by switching the input signal for "black" and "white" .

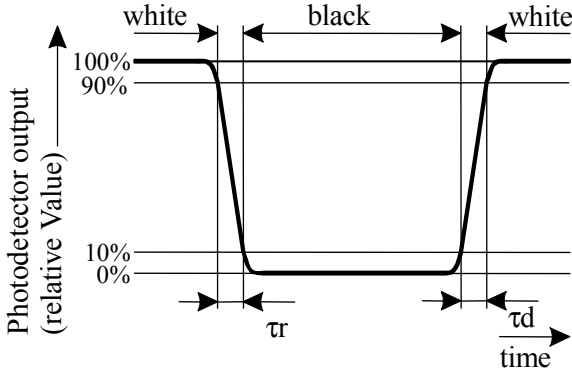

[Note4] This shall be measured at center of the screen.

[Note5] Definition of white uniformity:

White uniformity is defined as the following with five measurements (A ~ E).

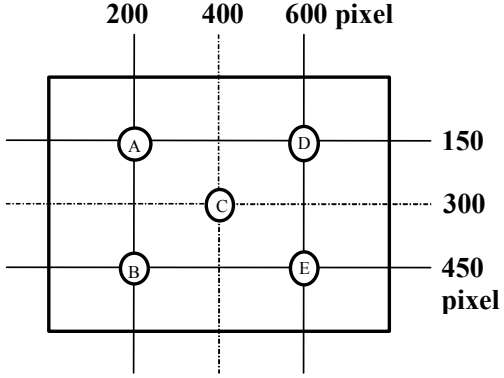

$$w = \frac{\text{Maximum Luminance of five points (brightness)}}{\text{Minimum Luminance of five points (brightness)}}$$

## 10. Display Quality

The display quality of the color TFT-LCD module shall be in compliance with the Incoming Inspection Standard.

## 11 . Handling Precautions

- a) Be sure to turn off the power supply when inserting or disconnecting the cable.
- b) Be sure to design the cabinet so that the module can be installed without any extra stress such as warp or twist.
- c) Since the front polarizer is easily damaged, pay attention not to scratch it.
- d) Wipe off water drop immediately. Long contact with water may cause discoloration or spots.
- e) When the panel surface is soiled, wipe it with absorbent cotton or other soft cloth.
- f) Since the panel is made of glass, it may break or crack if dropped or bumped on hard surface.  
Handle with care.
- g) Since CMOS LSI is used in this module, take care of static electricity and injure the human earth when handling. Observe all other precautionary requirements in handling components.
- h) Protection film is attached to the module surface to prevent it from being scratched .  
Peel the film off slowly , just before the use, with strict attention to electrostatic charges.  
Blow off 'dust' on the polarizer by using an ionized nitrogen.
- i) The polarizer surface on the panel is treated with Anti-Glare for low reflection. In case of attaching protective board over the LCD, be careful about the optical interface fringe etc. which degrades display quality.
- j) Do not expose the LCD panel to direct sunlight. Lightproof shade etc. should be attached when LCD panel is used under such environment.
- k) Connect GND to 4 place of mounting holes to stabilize against EMI and external noise.
- l) There are high voltage portions on the backlight and very dangerous. Careless touch may lead to electrical shock. When exchange lamps or service, turn off the power without fail.
- m) When handling LCD modules and assembling them into cabinets, please be noted that long-term storage in the environment of oxidization or deoxidization gas and the use of such materials as reagent, solvent, adhesive, resin, etc. which generate these gasses, may cause corrosion and discoloration of the LCD modules.
- n) Cold cathode fluorescent lamp in LCD panel contains a small amount of mercury, please follow local ordinances or regulations for disposal.

## 12. Packing form

- a) Piling number of cartons : MAX.T.B.D
- b) Package quantity in one carton : 10pcs
- c) Carton size : T.B.D (W) × T.B.D(H) × T.B.D(D) mm
- d) Total mass of one carton filled with full modules : T.B.D g

## 13 . Reliability test items

| No. | Test item                                       | Conditions  |
|-----|---|---|
| 1   | High temperature storage test                   | Ta=(70)°C 240h  |
| 2   | Low temperature storage test                    | Ta=-30°C 240h   |
| 3   | High temperature & high humidity operation test | Ta=40°C ; 95%RH 240h<br>(No condensation)   |
| 4   | High temperature operation test                 | Ta=65°C 240h  |
| 5   | Low temperature operation test                  | Ta=-10°C 240h   |
| 6   | Vibration test<br>(non- operating)              | Frequency :10 ~ 57Hz/Vibration width (one side):0.075mm<br>: 58 ~ 500Hz/Gravity:9.8m/s <sup>2</sup><br>Sweep time : 11 minutes<br>Test period : 3 hours<br>(1 hour for each direction of X,Y,Z) |
| 7   | Shock test<br>(non- operating)                  | Max. gravity : 490m/s <sup>2</sup><br>Pulse width : 11ms, sine wave<br>Direction :+/- X,+/- Y,+/- Z<br>once for each direction.   |

## [Result Evaluation Criteria]

Under the display quality test conditions with normal operation state, these shall be no change which may affect practical display function.

## 14 . Others

1) Lot No. Label :

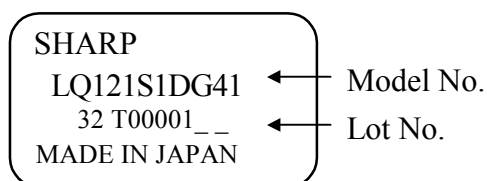

- 2) Adjusting volume have been set optimally before shipment, so do not change any adjusted value.  
If adjusted value is changed, the specification may not be satisfied.
- 3) Disassembling the module can cause permanent damage and should be strictly avoided.
- 4) Please be careful since image retention may occur when a fixed pattern is displayed for a long time.
- 5) If any problem occurs in relation to the description of this specification , it shall be resolved through discussion with spirit of cooperation.

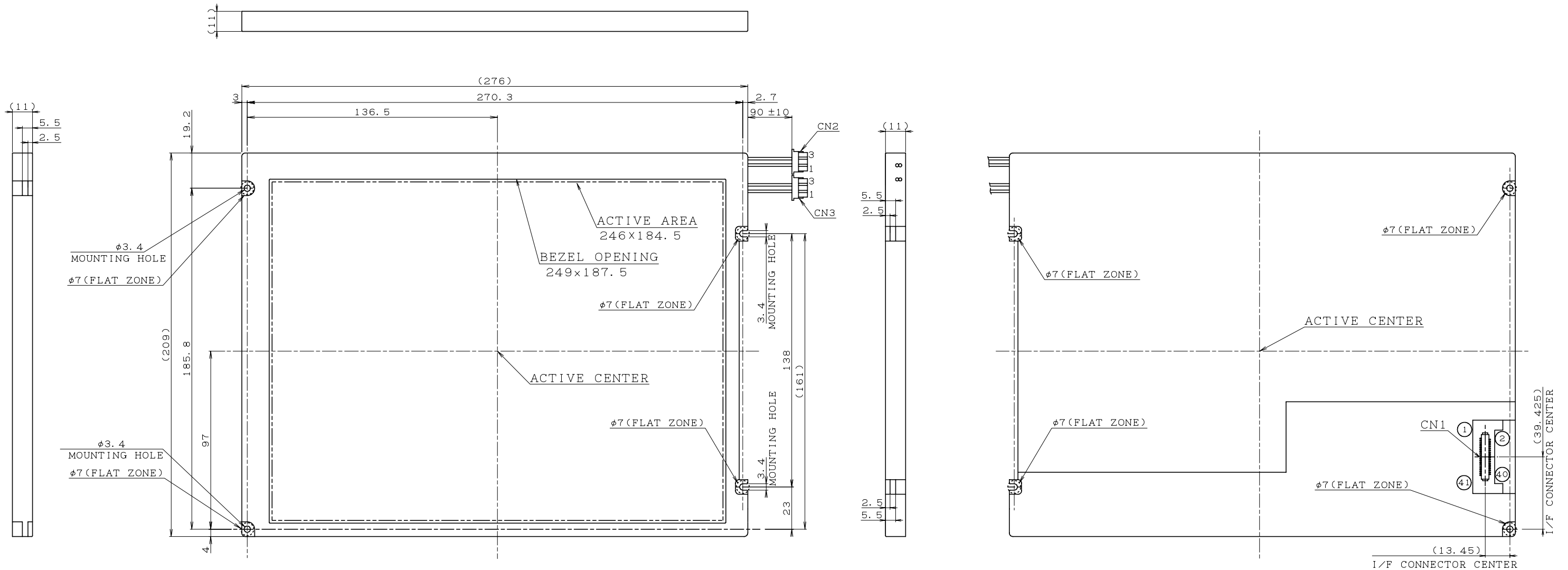

TENTATIVE

INTERFACE CONNECTOR

PIN LAYOUT (41PIN)

|     |     |     |     |                   |                   |      |     |     |     |     |     |     |     |    |    |    |
|-----|-----|-----|-----|-------------------|-------------------|------|-----|-----|-----|-----|-----|-----|-----|----|----|----|
| pin | 1   | 2   | 3   | 4                 | 5                 | 6    | 7   | 8   | 9   | 10  | 11  | 12  | 13  | 14 | 15 |    |
|     | GND | CK  | GND | H <sub>sync</sub> | V <sub>sync</sub> | GND  | GND | GND | R0  | R1  | R2  | GND | R3  | R4 | R5 |    |
| 16  | 17  | 18  | 19  | 20                | 21                | 22   | 23  | 24  | 25  | 26  | 27  | 28  | 29  | 30 | 31 |    |
|     | GND | GND | GND | G0                | G1                | G2   | GND | G3  | G4  | G5  | GND | GND | GND | B0 | B1 | B2 |
| 32  | 33  | 34  | 35  | 36                | 37                | 38   | 39  | 40  | 41  |     |     |     |     |    |    |    |
|     | GND | B3  | B4  | B5                | GND               | ENAB | R/L | VCC | VCC | U/D |     |     |     |    |    |    |

CORRESPONDING CONNECTOR: DF9-41S-1V, DF9A-41S-1V, DF9B-41S-1V, DF9M-41S-1V

BEZEL/DISPLAY POSITION

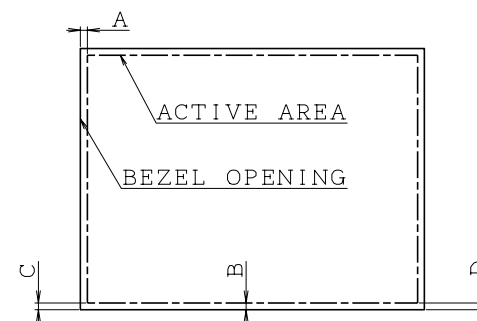

- 1) TOLERANCE X-DIRECTION A: 1.5±0.8
- 2) TOLERANCE Y-DIRECTION B: 1.5±0.8
- 3) OBLIQUITY OF DISPLAY AREA |C-D| < 0.8

CCFT CONNECTOR

CN2, CN3: BHR-03VS-1 (JST)

PIN LAYOUT

|   |      |
|---|------|
| 1 | High |
| 2 | NC   |
| 3 | GND  |

NOTES

- 1. UNSPECIFIED TOLERANCE TO BE ±0.5
- 2. WARP AND FLATING FOR PCB AND CHASSIS ARE EXCLUDED FROM THICKNESS AND DIMENSION OF THE UNIT.

Fig 1. OUTLINE DIMENSIONS