

Product Description: 65" Full HD Color TFT-LCD Module	
AUO Model Name: G645HW01 V0	
Customer Part No. / Project Name:	
Customer Signature	AU Optronics Corp.
	Approved by: PM Head Debbie Chiu
	Reviewed by: RD Head Kelvin Chou
	Reviewed by: Project Leader Steven Kuo
	Prepared by: PM Philip Weng
Note	

Product Functional Specification

65" Full HD Color TFT-LCD Module Model Name: G645HW01 V0

(*) Preliminary Specification
() Final Specification

Note: This specification is subject to change without notice.

Contents

No	
	CONTENTS
	RECORD OF REVISIONS
1	GENERAL DESCRIPTION
2	ABSOLUTE MAXIMUM RATINGS
3	ELECTRICAL SPECIFICATION
3.1	SIGNAL ELECTRICAL CHARACTERISTICS
3.2	SIGNAL INTERFACE CONNECTOR
3.3	SIGNAL TIMING SPECIFICATION
3.4	SIGNAL TIMING WAVEFORM
3.5	COLOR INPUT DATA REFERENCE
3.6	BACK LIGHT POWER SPECIFICATION
3.7	POWER SEQUENCE
4	OPTICAL SPECIFICATION
5	MECHANICAL CHARACTERISTICS
6	PACKING
7	RELIABILITY TEST
8	INTERNATIONAL STANDARD
9	PRECAUTIONS

1. General Description

This specification applies to the 65 inch Color TFT-LCD Module G645HW01 V0. This LCD module has a TFT active matrix type liquid crystal panel 1920x1080 pixels, and diagonal size of 64.5 inch. This module supports Full HD mode (non-interlace).

Each pixel is divided into Red, Green, and Blue sub-pixels or dots which are arranged in vertical stripes. Gray scale or the brightness of the sub-pixel color is determined by 10-bit gray scale signal for each dot.

The G645HW01 V0 has been designed to apply the 10-bit 2-channel LVDS interface method. It is intended to support displays where high brightness, wide viewing angle, and high color depth are important.

The G645HW01 V0 is RoHS verified which can be distinguished on panel label.

◆ General Information

Items	Specification	Unit	Note
Active Screen Size	64.53	inches	Diagonal
Display Area	1428.48 (H) x 803.52 (V)	mm	
Outline Dimension	1482.4(V) x 862.0(H) x 58.9(D)	mm	w/ Inverter Cover
Driver Element	a-Si TFT active matrix		
Display Colors	1073.7M (10-bit)	colors	
Color Gamut	72	%	NTSC
Number of Pixels	1920 x 1080	pixel	
Pixel Arrangement	RGB vertical stripe		
Pixel Pitch	0.744	mm	
Display Mode	Transmissive, Normally Black		
Surface Treatment	HCLR, 3H		
Total Power Consumption	TBD	watt	include BLU & Signal
Life Time (minimum)	50,000	hours	[1] [2]
RoHS	RoHS compliance		

Note [1]: The life is determined as the time at which luminance of the lamp is 50% compared to that of initial value at the typical lamp current on condition of continuous operating at 25±2°C.

Note [2]: The life is guaranteed only when panel is used under portrait display condition.

2. Absolute Maximum Ratings

The followings are maximum values which, if exceeded, may cause faulty operation or damage to the unit:

Item	Symbol	Min.	Max	Unit	Note
Logic/LCD Drive Voltage	V_{CC}	-0.3	+14.0	V	[1]
Input Voltage of Signal	V_{IN}	-0.3	+4.0	V	[1]
BLU Input Voltage	V_{DDB}	-0.3	+27.0	V	[1]
BLU Brightness Control Voltage	V_{BLON}	-0.3	+7.0	V	[1]
Operating Temperature	T_{OP}	0	+50	°C	[2]
Operating Humidity	H_{OP}	10	90	%RH	[2]
Storage Temperature	T_{ST}	-20	+60	°C	[2]
Storage Humidity	H_{ST}	10	90	%RH	[2]
Panel Surface Temperature	T_{SUR}	--	+65	°C	[2]
Open lamp Feedback Voltage	VFB	-0.3	+3.6	V	

Note [1]: If operate over spec but under absolute maximum rating, duration must be < 50ms.

Note [2]: Maximum Wet-Bulb should be 39°C and no condensation. The relative humidity must not exceed 80% non-condensing at temperatures of 40°C or less. At temperatures greater than 40°C, the wet bulb temperature must not exceed 39°C. When operate at low temperatures, the brightness of CCFL will drop and the life time of CCFL will be reduced.

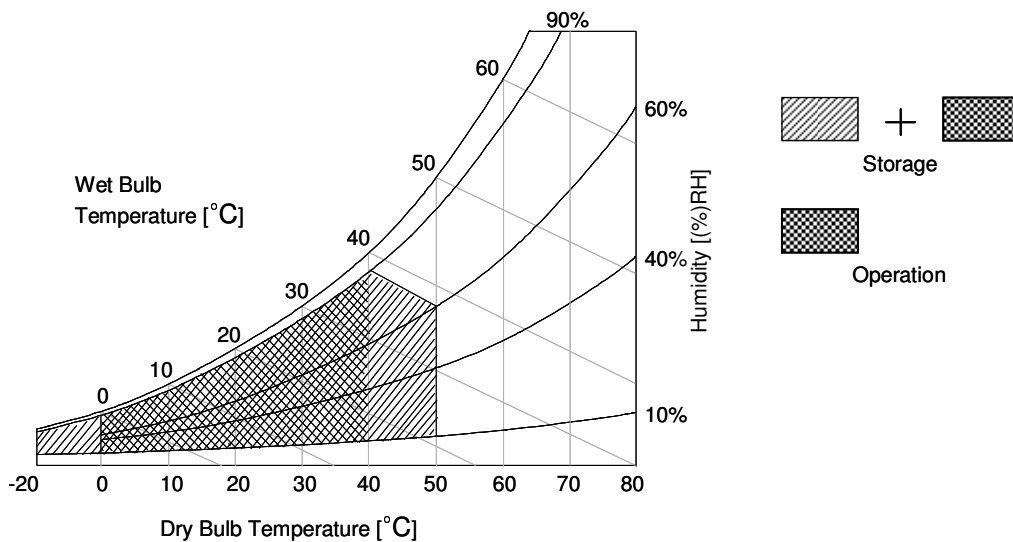

3. Electrical Specification

The G645HW01 V0 requires two power inputs. One is employed to power the LCD electronics and to drive the TFT array and liquid crystal. The second input is to power the inverter, which can power the CCFL.

3.1 Signal Electrical Characteristics

(Ta = 25 ± 2°C)

Parameter		Symbol	Value			Unit	Note
			Min.	Typ.	Max		
Power Supply Input Voltage		V _{CC}	10.8	12.0	13.2	V	
Power Supply Input Current		I _{CC}		2(TBD)		A	[2]
Power Consumption		P _{CC}		24(TBD)		Watt	[2]
Inrush Current		I _{RUSH}	--	--	4(TBD)	A	[3]
LVDS Interface	Differential Input High Threshold Voltage	V _{TH}	--	--	+100	mV	[4]
	Differential Input Low Threshold Voltage	V _{TL}	-100	--	--	mV	[4]
	Common Input Voltage	V _{CIM}	1.10	1.25	1.40	V	
CMOS Interface	Input High Threshold Voltage	V _{IH} (High)	2.4	--	3.3	V	
	Input Low Threshold Voltage	V _{IL} (Low)	0	--	0.7	V	

Note:

1. The check pattern is base on white pattern. The ripple voltage should be controlled under 10% of V_{CC}.
2. V_{CC} = 12.0V, F_V = 60Hz, F_{CLK} = 81.5Mhz, 25°C, V_{CC} duration time = 470μs, test pattern: full white pattern
3. Measurement condition: rising time=470μs

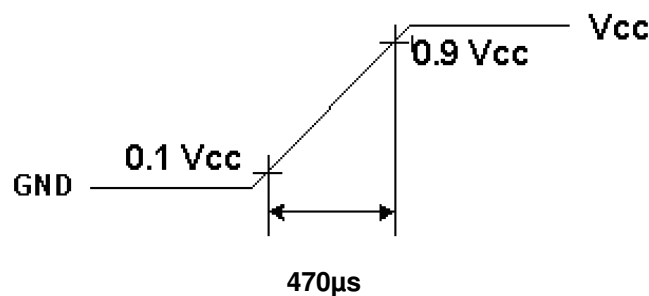

4. Measurement of LVDS differential voltage is shown as following:

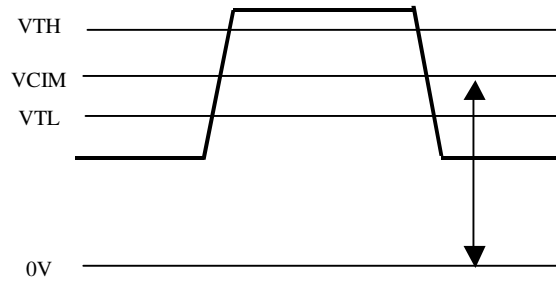

5. Do not attach a conducting tape to lamp connecting wire. If the lamp wire attach to conducting tape, TFT-LCD Module has a low luminance and the inverter has abnormal action because leakage current occurs between lamp wire and conducting tape.

3.2 Signal Interface Connections

◆ **LCD LVDS connector (51pin): JAE FI-RE51S-HF**

PIN #	Signal Name	Description	Note
1	Vcc	Operating Voltage Supply, +12V DC Regulated	Power
2	Vcc	Operating Voltage Supply, +12V DC Regulated	
3	Vcc	Operating Voltage Supply, +12V DC Regulated	
4	Vcc	Operating Voltage Supply, +12V DC Regulated	
5	Vcc	Operating Voltage Supply, +12V DC Regulated	
6	GND	Ground	
7	GND	Ground	
8	GND	Ground	
9	GND	Ground	
10	R1_0-	LVDS Channel 1, Signal 0-	LVDS Channel 1
11	R1_0+	LVDS Channel 1, Signal 0+	
12	R1_1-	LVDS Channel 1, Signal 1-	
13	R1_1+	LVDS Channel 1, Signal 1+	
14	R1_2-	LVDS Channel 1, Signal 2-	
15	R1_2+	LVDS Channel 1, Signal 2+	
16	GND	Ground	
17	R1_CLK-	LVDS Channel 1, Clock -	
18	R1_CLK+	LVDS Channel 1, Clock +	
19	GND	Ground	
20	R1_3-	LVDS Channel 1, Signal 3-	LVDS Channel 2
21	R1_3+	LVDS Channel 1, Signal 3+	
22	R1_4-	LVDS Channel 1, Signal 4-	
23	R1_4+	LVDS Channel 1, Signal 4+	
24	GND	Ground	
25	R2_0-	LVDS Channel 2, Signal 0-	
26	R2_0+	LVDS Channel 2, Signal 0+	
27	R2_1-	LVDS Channel 2, Signal 1-	
28	R2_1+	LVDS Channel 2, Signal 1+	
29	R2_2-	LVDS Channel 2, Signal 2-	
30	R2_2+	LVDS Channel 2, Signal 2+	
31	GND	Ground	
32	R2_CLK-	LVDS Channel 2, Clock -	
33	R2_CLK+	LVDS Channel 2, Clock +	
34	GND	Ground	
35	R2_3-	LVDS Channel 2, Signal 3-	

36	R2_3+	LVDS Channel 2, Signal 3+	
37	R2_4-	LVDS Channel 2, Signal 4-	
38	R2_4+	LVDS Channel 2, Signal 4+	
39	GND	Ground	
40	NC	No Connect (AUO Internal Use Only)	
41	NC	No Connect (AUO Internal Use Only)	
42	NC	No Connect (AUO Internal Use Only)	
43	NC	No Connect (AUO Internal Use Only)	
44	NC	No Connect (AUO Internal Use Only)	
45	LVDS_SEL	Open/High(3.3V) for NS, Low(GND) for JEIDA	Default: NS
46	NC	No Connect (AUO Internal Use Only)	
47	NC	No Connect (AUO Internal Use Only)	
48	NC	No Connect (AUO Internal Use Only)	
49	NC	No Connect (AUO Internal Use Only)	
50	NC	No Connect (AUO Internal Use Only)	
51	NC	No Connect (AUO Internal Use Only)	

Note [1]: All GND (ground) pins should be connected together and should also be connected to the LCD's metal frame.

Note [2]: All V_{CC} (power input) pins should be connected together.

Note [3]: All NC (no connection) pins should be open without voltage input.

◆ **LVDS SEL= Open/High(3.3V) → NS**

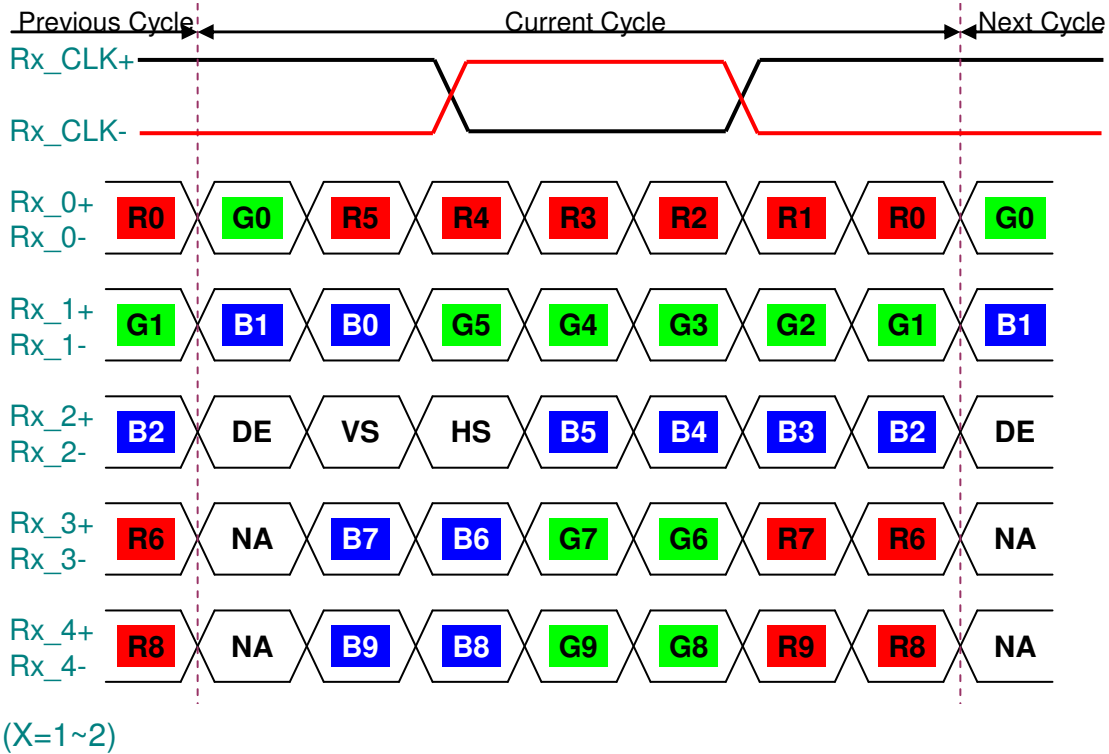

◆ **LVDS SEL = Low(GND) → JEIDA**

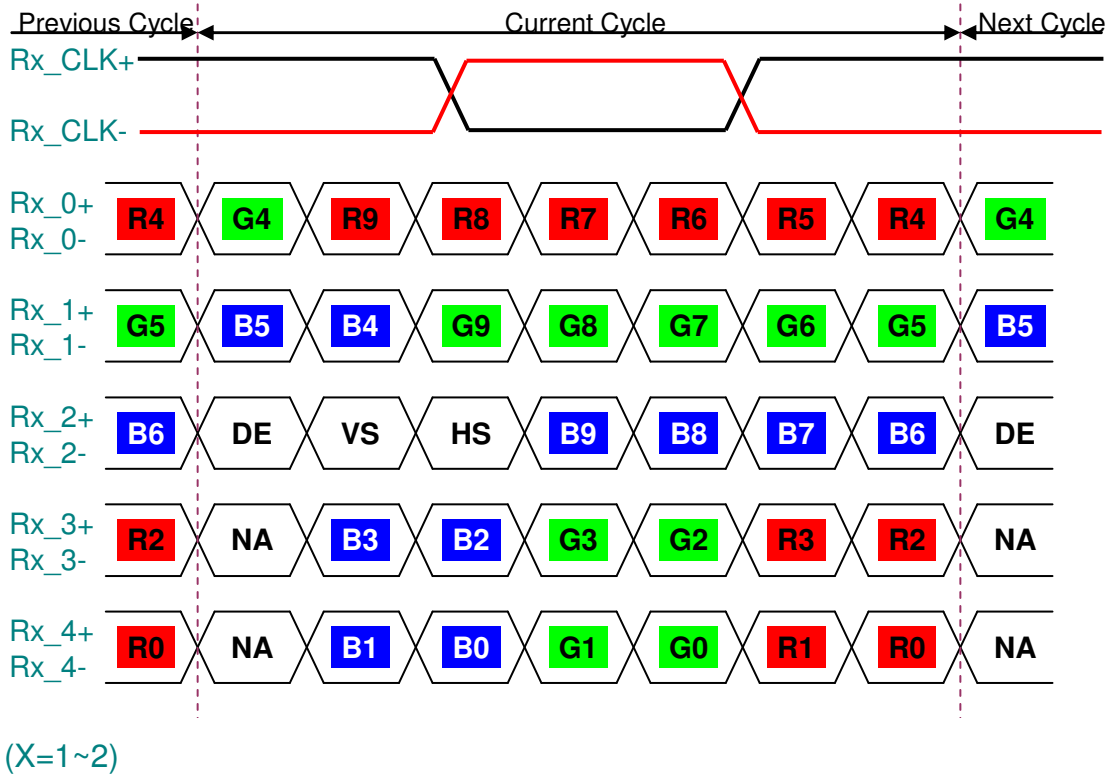

3.3 Signal Timing Specification

This is the signal timing required at the input of the user connector. All of the interface signal timing should be satisfied with the following specifications for its proper operation.

Timing Table (DE only Mode)

Signal	Item	Symbol	Min.	Typ.	Max	Unit
Vertical Section	Period	T_V	--	1190	--	T_H
	Active	$T_{disp} (V)$	1080			
	Blanking	$T_{blk} (V)$	--	110	--	T_H
Horizontal Section	Period	T_h	--	2100	--	T_{CLK}
	Active	$T_{disp} (H)$	1920			
	Blanking	$T_{blk} (H)$	--	180	--	T_{CLK}
Clock	Period	T_{CLK}	--	13.33	--	ns
	Frequency	F_{CLK}	--	150	--	MHz
Vertical Frequency	Frequency	F_V	--	60	--	Hz
Horizontal Frequency	Frequency	F_H	--	71.4	--	KHz

Note [1]: Display position is specific by the rise of DE signal only.

Horizontal display position is specified by the falling edge of 1st DCLK right after the rise of ENAB, is displayed on the left edge of the screen.

Vertical display position is specified by the rise of DE after a "Low" level period equivalent to eight times of horizontal period. The 1st data corresponding to one horizontal line after the rise of ENAB is displayed at the top line of screen.

Note [2]: If a period of DE "High" is less than 1920 DCLK or less than 1080 lines, the rest of the screen displays black.

Note [3]: The display position does not fit to the screen if a period of DE "High" and the effective data period do not synchronize with each other.

3.4 Signal Timing Waveform

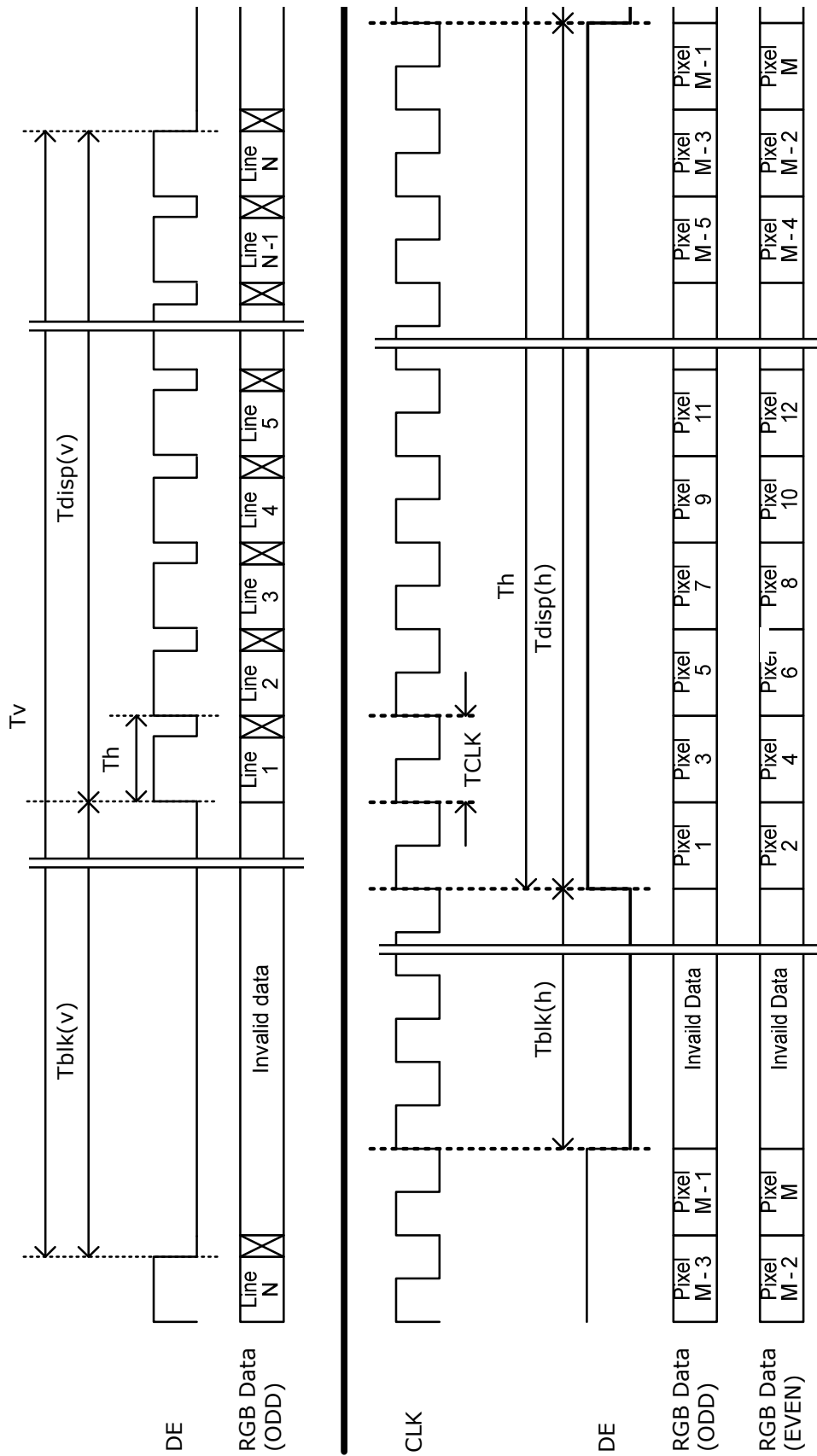

3.5 Color Input Data Reference

The brightness of each primary color (red, green, and blue) is based on the 10-bit gray scale data input for the color; the higher the binary input, the brighter the color. The table below provides a reference for color versus data input.

COLOR DATA REFERENCE

COLOR		INPUT COLOR DATA																														
		RED										GREEN										BLUE										
		MSB					LSB					MSB					LSB					MSB			LSB							
		R9	R8	R7	R6	R5	R4	R3	R2	R1	R0	G9	G8	G7	G6	G5	G4	G3	G2	G1	G0	B9	B8	B7	B6	B5	B4	B3	B2	B1	B0	
Basic Color	Black	0	0	0	0	0	0	0	0	0	0	0	0	0	0	0	0	0	0	0	0	0	0	0	0	0	0	0	0	0	0	0
	Red(255)	1	1	1	1	1	1	1	1	1	1	0	0	0	0	0	0	0	0	0	0	0	0	0	0	0	0	0	0	0	0	0
	Green(255)	0	0	0	0	0	0	0	0	0	0	1	1	1	1	1	1	1	1	1	1	1	0	0	0	0	0	0	0	0	0	0
	Blue(255)	0	0	0	0	0	0	0	0	0	0	0	0	0	0	0	0	0	0	0	0	0	1	1	1	1	1	1	1	1	1	1
	Cyan	0	0	0	0	0	0	0	0	0	0	1	1	1	1	1	1	1	1	1	1	1	1	1	1	1	1	1	1	1	1	1
	Magenta	1	1	1	1	1	1	1	1	1	1	0	0	0	0	0	0	0	0	0	0	0	1	1	1	1	1	1	1	1	1	1
	Yellow	1	1	1	1	1	1	1	1	1	1	1	1	1	1	1	1	1	1	1	1	1	0	0	0	0	0	0	0	0	0	0
	White	1	1	1	1	1	1	1	1	1	1	1	1	1	1	1	1	1	1	1	1	1	1	1	1	1	1	1	1	1	1	1
Red	Red(000)	0	0	0	0	0	0	0	0	0	0	0	0	0	0	0	0	0	0	0	0	0	0	0	0	0	0	0	0	0	0	
	Red(001)	0	0	0	0	0	0	0	0	0	1	0	0	0	0	0	0	0	0	0	0	0	0	0	0	0	0	0	0	0	0	
	:																															
	Red(254)	1	1	1	1	1	1	1	1	1	0	0	0	0	0	0	0	0	0	0	0	0	0	0	0	0	0	0	0	0	0	
	Red(255)	1	1	1	1	1	1	1	1	1	1	0	0	0	0	0	0	0	0	0	0	0	0	0	0	0	0	0	0	0	0	
Green	Green(000)	0	0	0	0	0	0	0	0	0	0	0	0	0	0	0	0	0	0	0	0	0	0	0	0	0	0	0	0	0	0	
	Green(001)	0	0	0	0	0	0	0	0	0	0	0	0	0	0	0	0	0	0	0	1	0	0	0	0	0	0	0	0	0	0	
	:																															
	Green(254)	0	0	0	0	0	0	0	0	0	0	1	1	1	1	1	1	1	1	1	0	0	0	0	0	0	0	0	0	0	0	
	Green(255)	0	0	0	0	0	0	0	0	0	0	1	1	1	1	1	1	1	1	1	1	0	0	0	0	0	0	0	0	0	0	
Blue	Blue(000)	0	0	0	0	0	0	0	0	0	0	0	0	0	0	0	0	0	0	0	0	0	0	0	0	0	0	0	0	0	0	
	Blue(001)	0	0	0	0	0	0	0	0	0	0	0	0	0	0	0	0	0	0	0	0	0	0	0	0	0	0	0	0	0	1	
	:																															
	Blue(254)	0	0	0	0	0	0	0	0	0	0	0	0	0	0	0	0	0	0	0	0	1	1	1	1	1	1	1	1	1	0	
	Blue(255)	0	0	0	0	0	0	0	0	0	0	0	0	0	0	0	0	0	0	0	0	1	1	1	1	1	1	1	1	1	1	

3.6 Backlight Power Specification

◆ Electrical Specification

($T_a=25\pm 5^\circ\text{C}$, Turn-on after 60mins, $V_{DDB}=24\text{V}$)

	Item	Symbol	Specification			Unit	Note	
			Min.	Typ.	Max			
1	Input Voltage	V_{DDB}	21.6	24.0	26.4	V		
2	Input Current	I_{DDB}	--	16		A	[1]	
3	Input Power	P_{DDB}	--	384		Watt	[1]	
4	Inrush Current	I_{DD_RUSH}	--	--	15	A	[2]	
5	Output Frequency	F_{BL}		42		kHz		
6	On/Off Control Voltage	V_{BLON}	ON	2.0	--	5.0	V	
			OFF	0	--	0.8	V	
7	On/Off Control Current	I_{BLON}	0	--	2.0	mA		
8	Dimming Control Voltage	V_{DIM}	MAX	3	--	3.3	V	
			MIN	0	--	0.8	V	
9	Dimming Control Current	I_{DIM}	0	--	2.0	mA		
10	Dimming Frequency	F_{DIM}		180		Hz		
11	External PWM Control Voltage	V_{EPWM}	MAX		3.3		V	
			MIN		0		V	
12	External PWM Control Current	I_{EPWM}	0	--	2.0	mA		
13	External PWM Duty Ratio	D_{EPWM}	30	--	100	%	[3]	
14	External PWM Frequency	F_{EPWM}		180		Hz		
15	Feedback signal On/Off Voltage	FB1, FB2	ON	2.0	--	3.3	V	
			OFF	0	--	0.8	V	

Note [1]: The specification value is under $V_{DIM} = 3.3\text{V}$, EPWM = Open or High

Note [2]: Measurement condition: rising time = 20ms (V_{DDB} : 10%→90%)

Note [3]: If operation below 20% dimming duty, (a) function is okay and no backlight shut down,
 (b) uniformity, lifetime, and flicker do not guarantee.

◆ **Inverter Interface Connection**

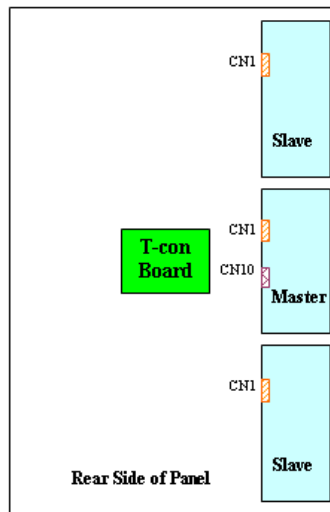

CN1 of Master Board: S14B-PH-SM3-TB (JST) or Compatible

PIN #	Symbol	Description
1	V _{DDB}	Operating Voltage Supply, +24V DC Regulated
2	V _{DDB}	Operating Voltage Supply, +24V DC Regulated
3	V _{DDB}	Operating Voltage Supply, +24V DC Regulated
4	V _{DDB}	Operating Voltage Supply, +24V DC Regulated
5	V _{DDB}	Operating Voltage Supply, +24V DC Regulated
6	GND	Ground
7	GND	Ground
8	GND	Ground
9	GND	Ground
10	GND	Ground
11	NC	No Connect (AUO Internal Use Only)
12	V _{BLON}	Backlight On/Off: Open/High(+3.3V) for BL on, Low(GND) for BL off
13	PDIM [1]	External PWM Dimming Control input; Open/High (3.3V/100% Duty) for 100% Lum ; Internal PWM: Open/High (3.3V/100% Duty) for 100% Lum; GND for 30%
14	PDIM Selection [2]	High (3.3V): Internal PWM Dimming Low (GND)/Open: External PWM dimming

Note [1]: PDIM is PWM duty control Input for +3.3V TTL Level Signal. This Input Signal is Continuous Pulse Signal with +3.3V, TTL Level Signal Spec. If this is Open or +3.3V, 100% Duty (i.e. +3.3V, DC level), Back Light should perform 100% Luminance. Duty Ratio of this Input signal should be proportional relationship in certain range of control without any

kind of inherent side effect like Waterfall effect on Screen. Guaranteed Duty Range and Dimming Ratio should be specified with supplementary measurement result.

Note [2]: 14 Pin is selection pin for Back Light Dimming Control method;

If this pin is connected to Open/Low(GND) :

- PDIM input of 13th Pin should have Logic Level Duty Signal for PWM duty control. If this pin is connected to high (3.3V)
- PDIM input of 13th Pin should have external voltage to control (3.3V/100% Duty → GND/30%Duty).

CN10 of Master Board: S3B-ZR-SM3A-TF (JST)

Pin No	Symbol	Description	Note
1	FB1	Feedback pin 1 (Sensor open lamp signal)	[1]
2	FB2	Feedback pin 2 (Sensor open lamp signal)	[1]
3	GND	Ground	

Note [1]: Lamp status feedback signal:

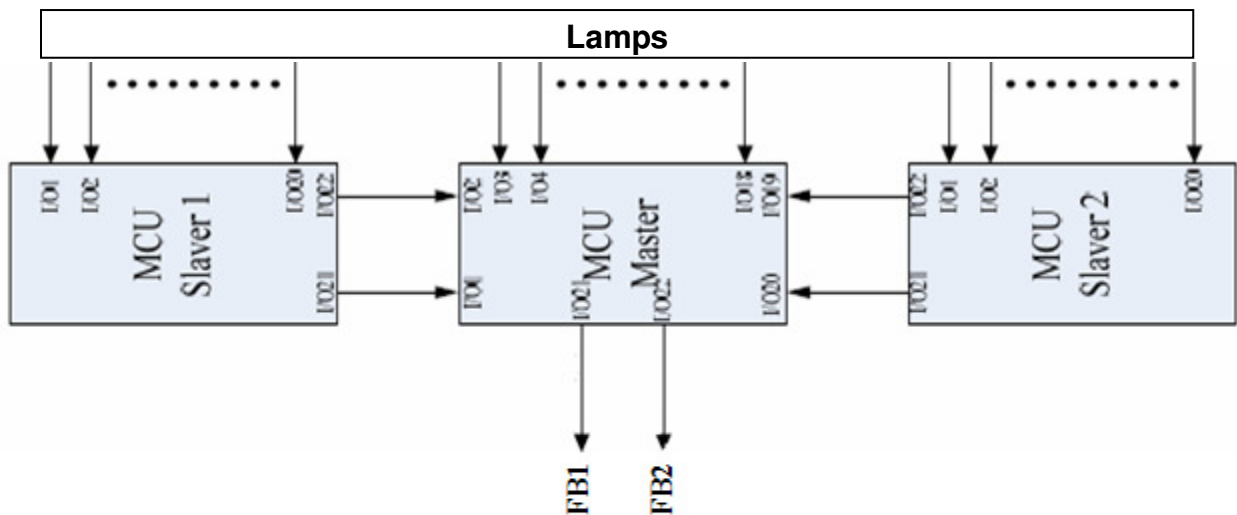

Lamp status	(FB1, FB2)
Normal	(L , L)
1 Lamp Open	(L , H)
2~3 Lamps Open	(H , L)
Shut down	(H , H)

CN1 of Slaver Board: S12B-PH-SM3-TB (JST) or Compatible

PIN #	Symbol	Description
1	V _{DDB}	Operating Voltage Supply, +24V DC Regulated
2	V _{DDB}	Operating Voltage Supply, +24V DC Regulated
3	V _{DDB}	Operating Voltage Supply, +24V DC Regulated
4	V _{DDB}	Operating Voltage Supply, +24V DC Regulated
5	V _{DDB}	Operating Voltage Supply, +24V DC Regulated
6	V _{DDB}	Operating Voltage Supply, +24V DC Regulated
7	GND	Ground
8	GND	Ground
9	GND	Ground
10	GND	Ground
11	GND	Ground
12	GND	Ground

Note [1]: All GND (ground) pins for each connector should be connected together and should also be connected to the LCD's metal frame.

Note [2]: All V_{DDB} (power input) pins for each connector should be connected together.

3.7 Power Sequence

◆ Power Sequence of LCD

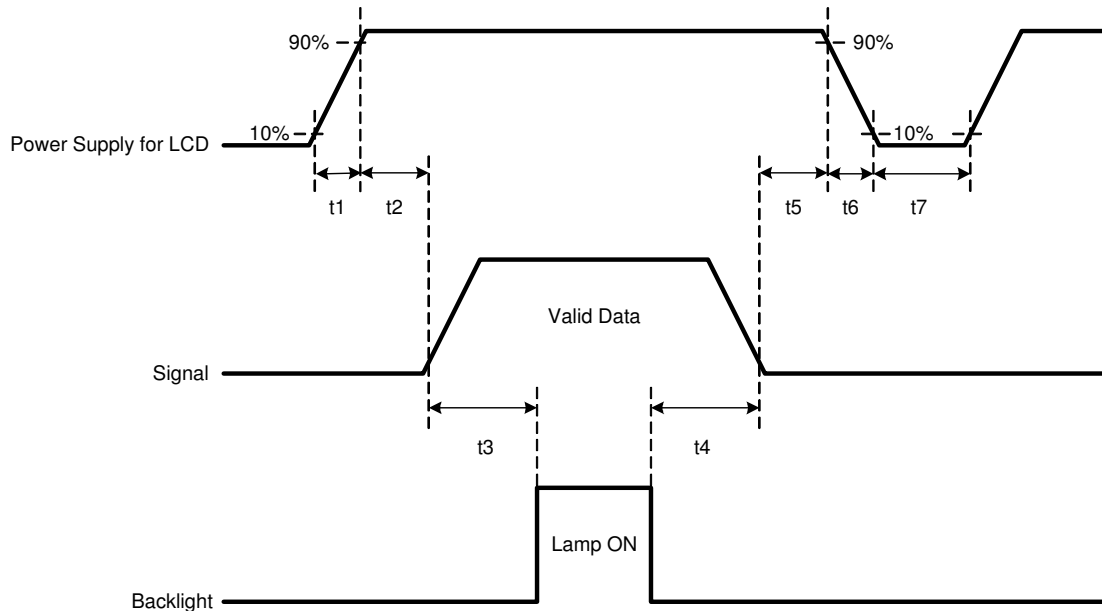

Parameter	Values			Unit
	Min.	Typ.	Max.	
t1	0.47	--	30	ms
t2	0.1	--	50	ms
t3	500	--	--	ms
t4	100	--	--	ms
t5	0.1	--	50	ms
t6	--	--	30	ms
t7	1000	--	--	ms

Note [1]: Apply the lamp voltage within the LCD operating range. When the backlight turns on before the LCD operation or the LCD turns off before the backlight turns off, the display may momentarily become abnormal.

Caution: The above on/off sequence should be applied to avoid abnormal function in the display. In case of handling, make sure to turn off the power when you plug the cable into the input connector or pull the cable out of the connector.

◆ **Power Sequence of Inverter**

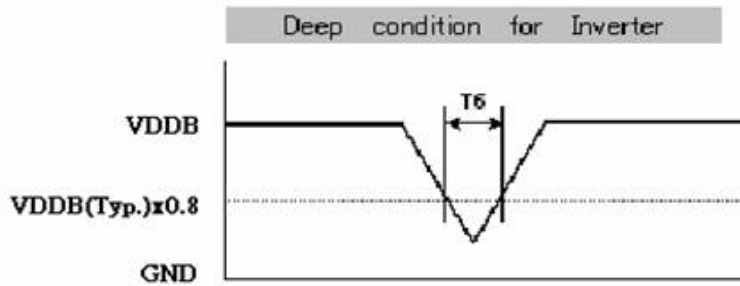
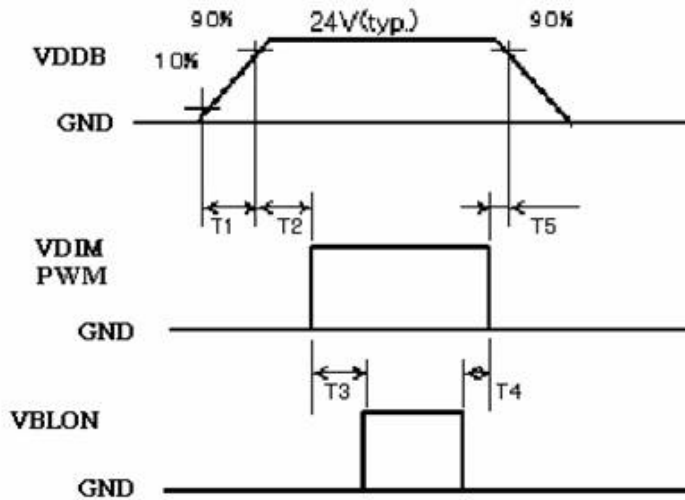

Parameter	Values			Unit
	Min.	Typ.	Max.	
T1	20	--	--	ms
T2	500	--	--	ms
T3	250	--	--	ms
T4	0	--	--	ms
T5	1	--	50	ms
T6	--	--	10	ms

4. Optical Specification

Optical characteristics are determined after the unit has been 'ON' and stable for approximately 60 minutes in a dark environment at 25°C. The values specified are at an approximate distance 50cm from the LCD surface at a viewing angle of φ and θ equal to 0°.

Test condition:

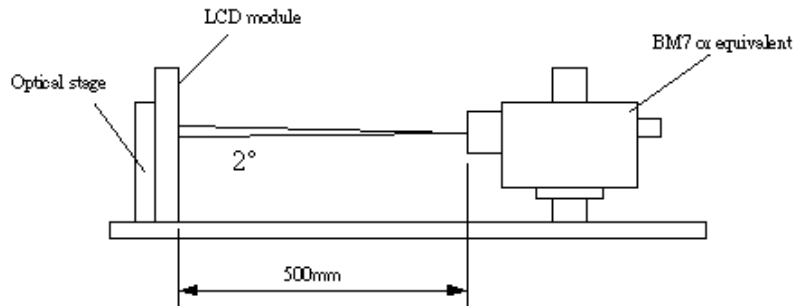

($T_a=25\pm 5^\circ\text{C}$, Turn-on after 60mins)

Parameter	Symbol	Values			Unit	Notes
		Min.	Typ.	Max		
Contrast Ratio	CR	1500	2000	--		[1], [2]
Surface Luminance (White)	L_{WH}	550	700	--	cd/m ²	[1], [3]
Luminance Variation	$\delta_{WHITE(9P)}$	--	--	1.3		[4]
Response Time (Average)	T_R	--	5.5(TBD)	--	ms	[1],[5] (Gray to Gray)
Color Coordinates						(CIE 1931)
Red	R_x	Typ.-0.03	0.64	Typ.+0.03		[1]
	R_y		0.33			[1]
Green	G_x		0.29			[1]
	G_y		0.60			[1]
Blue	B_x		0.15			[1]
	B_y		0.06			[1]
White	W_x		0.28			[1]
	W_y		0.29			[1]
Viewing Angle						(Contrast Ratio>10)
x axis, right($\varphi=0^\circ$)	θ_r	--	89	--	degree	[1], [6]
x axis, left($\varphi=180^\circ$)	θ_l	--	89	--	degree	[1], [6]
y axis, up($\varphi=90^\circ$)	θ_u	--	89	--	degree	[1], [6]
y axis, down ($\varphi=270^\circ$)	θ_d	--	89	--	degree	[1], [6]

Note [1]: The values of contrast ratio, surface luminance, response time, color coordinates, and viewing angle are measured at center point of display area.

Note [2]: Contrast Ratio (CR) is defined mathematically as:

$$\text{Contrast Ratio (CR)} = \frac{\text{Brightness of 'full white' state}}{\text{Brightness of 'full black' state}}$$

Note [3]: Surface Luminance is luminance value at center point of display area, 50cm from the surface with all pixels displaying white.

Note [4]: The variation in surface luminance, $\delta_{\text{WHITE(9P)}}$ is defined as:

$$\delta_{\text{WHITE(9P)}} = \text{Maximum}(L_{\text{on1}}, L_{\text{on2}}, \dots, L_{\text{on9}}) / \text{Minimum}(L_{\text{on1}}, L_{\text{on2}}, \dots, L_{\text{on9}})$$

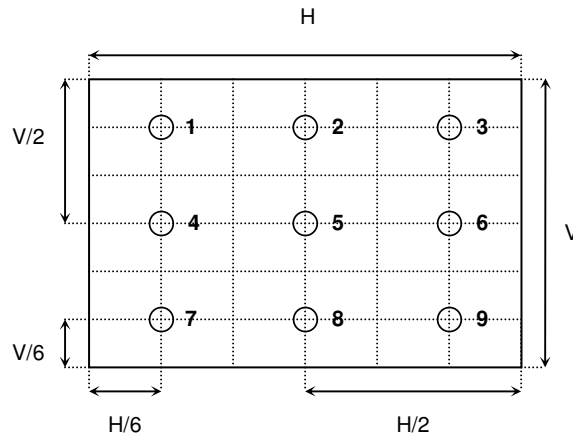

Note [5]: Response time TR is the average time required for display transition by switching the input signal for five luminance ratio (0%, 25%, 50%, 75%, 100% brightness matrix) and is based on $F_V = 60\text{Hz}$ to optimize.

	0%	25%	50%	75%	100%
0%		t0%-25%	t0%-50%	t0%-75%	t0%-100%
25%	t25%-0%		t25%-50%	t25%-75%	t25%-100%
50%	t50%-0%	t50%-25%		t50%-75%	t50%-100%
75%	t75%-0%	t75%-25%	t75%-50%		t50%-100%
100%	t100%-0%	t100%-25%	t100%-50%	t100%-75%	

Note [6]: Viewing angle is the angle at which the contrast ratio is greater than 10. The angles are determined for the horizontal (or x-axis) and the vertical (or y-axis) with respect to the z-axis which is normal to the LCD surface.

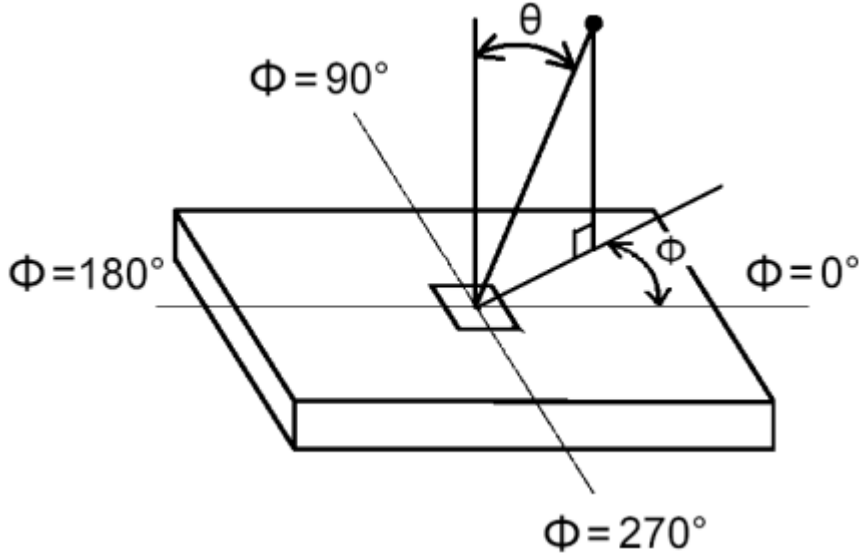

5. Mechanical Characteristics

The contents provide general mechanical characteristics for the model G645HW01 V0. Detailed mechanical drawings are shown in the following pages.

Outline Dimension	Horizontal (typ.)	1482.4 mm
	Vertical (typ.)	862.0 mm
	Depth (typ.)	58.9 mm (with inverter)
Bezel Opening Area	Horizontal (typ.)	814.6 mm
	Vertical (typ.)	1440.6 mm
Active Display Area	Horizontal	803.52 mm
	Vertical	1428.48 mm
Weight	30 KG (Max)	

2D Drawing (Front) - Draft

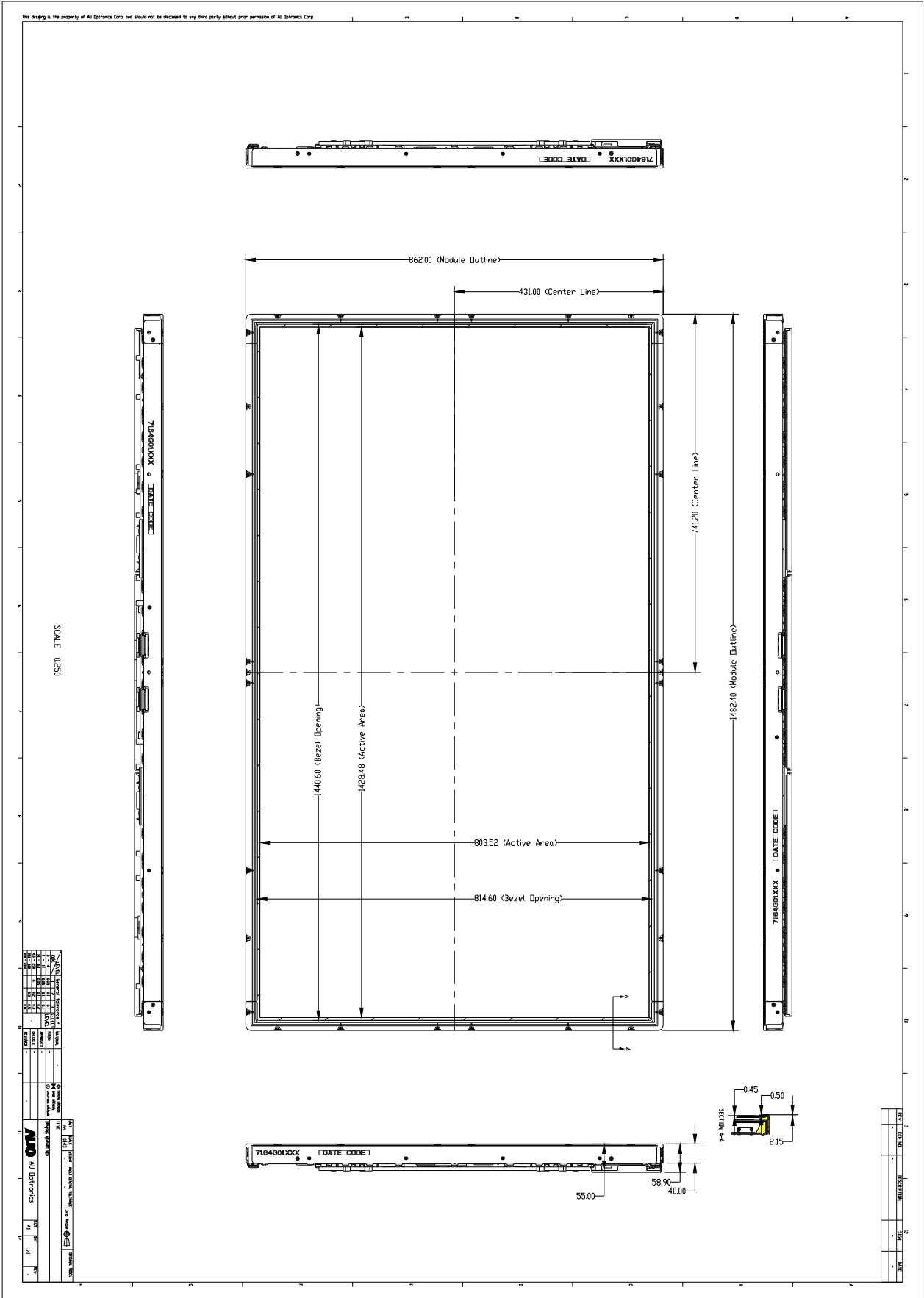

6. Packing

- A. Panel Label
- B. Carton Label
- C. Packing Instruction
- D. Packing Specification

[Packing information will be updated in next specification revision.]

7. Reliability Test

No	Test Item	Q'ty	Condition
1	High Temperature Storage	3 pcs	Ta = 60°C, 300Hr Judge
2	Low Temperature Storage	3 pcs	Ta = -20°C, 300Hr Judge
3	High Temperature Operation	3 pcs	Ta = 50°C, 300Hr Judge
4	Low Temperature Operation	3 pcs	Ta = -5°C , 300Hr Judge
5	Vibration Test (non-operating)	3 pcs	Waveform: random Vibration Level: 1.5G RMS Bandwidth: 1-500Hz Duration: X, Y, Z 30min one time each direction
6	Shock Test (non-operating)	3 pcs	Shock Level: 50G Waveform: sine wave, 11ms Direction: ±X, ±Y, ±Z one time each direction
7	Vibration Test (with carton)	1 box	Waveform: random Vibration Level: 1.5G RMS Bandwidth:10-200Hz Duration: 30min in each X, Y, Z direction
8	Drop Test (with carton)	1 box	Height: 31cm 1 corner, 3 edges, 6 surfaces (ASTMD5276

8. International Standard

8.1 Safety

- (1) UL60065,2003, Underwriters Laboratories, Inc. (AUO file number : E204356)
Audio, video and similar electronic apparatus, safety requirement
- (2) UL60950-1,2003, Underwriters Laboratories, (AUO file number : E204356)
Standard for safety of information technology equipment including electrical business equipment
- (3) EN60065
- (4) EN60950
- (5) IEC 60065, European Committee for Electro technical Standardization (CENELEC)
Audio, video and similar electronic apparatus, safety requirement
- (6) IEC 60950-1:
European Committee for Electrotechnical Standardization (CENELEC)
European Standard for safety of information technology equipment including electrical business equipment

8.2 EMC

- (1) ANSI C63.4 "Methods of Measurement of Radio-Noise Emissions from Low-Voltage Electrical and Electrical Equipment in the Range of 9kHz to 40GHz. "American National standards Institute(ANSI), 1992
- (2) C.I.S.P.R "Limits and Methods of Measurement of Radio Interface Characteristics of Information Technology Equipment." International Special committee on Radio Interference.
- (3) EN 55022 "Limits and Methods of Measurement of Radio Interface Characteristics of Information Technology Equipment." European Committee for Electrotechnical Standardization. (CENELEC), 1998

9. Precautions

Please pay attention to the followings when you use this TFT LCD module.

9.1 MOUNTING PRECAUTIONS

- (1) You must mount a module using holes arranged on back or edge side of panel.
- (2) You should consider the mounting structure so that uneven force (ex. twisted stress) is not applied to module. And the case on which a module is mounted should have sufficient strength so that external force is not transmitted directly to the module.
- (3) Please attach the surface transparent protective plate to the surface in order to protect the polarizer. Transparent protective plate should have sufficient strength in order to resist external force.
- (4) You should adopt radiation structure to satisfy the temperature specification.
- (5) Acetic acid type and chlorine type materials for the cover case are not desirable because the former generates corrosive gas of attacking the polarizer at high temperature and the latter cause circuit break by electro-chemical reaction.
- (6) Do not touch, push or rub the exposed polarizer with glass, tweezers or anything harder than HB pencil lead. And please do not rub with dust clothes with chemical treatment. Do not touch the surface of polarizer for bare hand or greasy cloth. (Some cosmetics are detrimental to the polarizer.)
- (7) When the surface becomes dusty, please wipe gently with absorbent cotton or other soft materials like chamois soaks with petroleum benzene. Normal-hexane is recommended for cleaning the adhesives used to attach front/rear polarizer. Do not use acetone, toluene and alcohol because they cause chemical damage to the polarizer.
- (8) Wipe off saliva or water drops as soon as possible. Their long time contact with polarizer causes deformations and color fading.
- (9) Do not open the case because inside circuits do not have sufficient strength.

9.2 OPERATING PRECAUTIONS

- (1) The spike noise causes the mis-operation of circuits. It should be lower than following voltage:
 $V = \pm 200\text{mV}$ (over and under shoot voltage)
- (2) Response time depends on the temperature. (In lower temperature, it becomes longer.)
- (3) Brightness of CCFL depends on the temperature. (In lower temperature, it becomes lower.) And in lower temperature, response time (required time that brightness is stable after turned on) becomes longer.
- (4) Be careful for condensation at sudden temperature change. Condensation makes damage to polarizer or electrical contacted parts. And after fading condensation, smear or spot will occur.
- (5) When fixed patterns are displayed for a long time, remnant image is likely to occur.
- (6) Module has high frequency circuits. Sufficient suppression to the electromagnetic interference shall be done by system manufacturers. Grounding and shielding methods may be important to minimize the interface.

9.3 ELECTROSTATIC DISCHARGE CONTROL

Since a module is composed of electronic circuits, it is not strong to electrostatic discharge. Make certain that treatment persons are connected to ground through wrist band etc. And don't touch interface pin directly.

9.4 PRECAUTIONS FOR STRONG LIGHT EXPOSURE

Strong light exposure causes degradation of polarizer and color filter.

9.5 STORAGE

When storing modules as spares for a long time, the following precautions are necessary.

- (1) Store them in a dark place. Do not expose the module to sunlight or fluorescent light. Keep the temperature between 5°C and 35°C at normal humidity.
- (2) The polarizer surface should not come in contact with any other object. It is recommended that they be stored in the container in which they were shipped.

9.6 HANDLING PRECAUTIONS FOR PROTECTION FILM

- (1) The protection film is attached to the bezel with a small masking tape. When the protection film is peeled off, static electricity is generated between the film and polarizer. This should be peeled off slowly and carefully by people who are electrically grounded and with well ion-blown equipment or in such a condition, etc.
- (2) When the module with protection film attached is stored for a long time, sometimes there remains a very small amount of flue still on the Bezel after the protection film is peeled off.
- (3) You can remove the glue easily. When the glue remains on the Bezel or its vestige is recognized, please wipe them off with absorbent cotton waste or other soft material like chamois soaked with normal-hexane.

9.7 Operating Condition in PID Application

- (1) If the continuous static display is required, periodically inserting a motion picture is strongly recommended.
- (2) Recommend to periodically change the background color and background image.
- (3) Recommend not to continuously operate over 18 hours a day.
- (4) Recommend to adopt one of the following actions after long time display.
 - I. Running the screen saver (motion picture or black pattern)
 - II. Power off the system for a while
- (5) Try not to run the LCD in a closed environment. Suitable venting on the system cover would be helpful for cooling.
- (6) It is better to adapt active cooling with fans for long time displaying, especially for high luminance LCD model.