

Model Name: T460HW04 V0

Issue Date : 2009/10/07

(*) Preliminary Specifications
() Final Specifications

| Customer Signature | Date | AUO | Date |
|--------------------------|------|--|------|
| Approved By _____ | | Approval By PM Director Frank Hsu _____ | |
| Note | | Reviewed By RD Director Eugene CC Chen _____ | |
| | | Reviewed By Project Leader SJ Chen _____ | |
| | | Prepared By PM Alex CC Wang _____ | |

Contents

| No | | |
|----|-----|---------------------------------------|
| | | CONTENTS |
| | | RECORD OF REVISIONS |
| 1 | | GENERAL DESCRIPTION |
| 2 | | ABSOLUTE MAXIMUM RATINGS |
| 3 | | ELECTRICAL SPECIFICATION |
| | 3-1 | ELECTRICAL CHARACTERISTICS |
| | 3-2 | INTERFACE CONNECTIONS |
| | 3-3 | SIGNAL TIMING SPECIFICATION |
| | 3-4 | SIGNAL TIMING WAVEFORM |
| | 3-5 | COLOR INPUT DATA REFERENCE |
| | 3-6 | POWER SEQUENCE |
| | 3-7 | BACKLIGHT SPECIFICATION |
| 4 | | OPTICAL SPECIFICATION |
| 5 | | MECHANICAL CHARACTERISTICS |
| 6 | | RELIABILITY TEST ITEMS |
| 7 | | INTERNATIONAL STANDARD |
| | 7-1 | SAFETY |
| | 7-2 | EMC |
| 8 | | PACKING |
| | 8-1 | DEFINITION OF LABEL |
| | 8-2 | PACKING METHODS |
| | 8-3 | PALLET AND SHIPMENT INFORMATION |
| 9 | | PRECAUTION |
| | 9-1 | MOUNTING PRECAUTIONS |
| | 9-2 | OPERATING PRECAUTIONS |
| | 9-3 | ELECTROSTATIC DISCHARGE CONTROL |
| | 9-4 | PRECAUTIONS FOR STRONG LIGHT EXPOSURE |
| | 9-5 | STORAGE |
| | 9-6 | HANDLING PRECAUTIONS FOR PROTECT FILM |

1. General Description

This specification applies to the 46.0 inch Color TFT-LCD Module T460HW04 V1. This LCD module has a TFT active matrix type liquid crystal panel 1,920x1,080 pixels, and diagonal size of 46.0 inch. This module supports 1,920x1080 mode. Each pixel is divided into Red, Green and Blue sub-pixels or dots which are arranged in vertical stripes. Gray scale or the brightness of the sub-pixel color is determined with a 10-bit gray scale signal for each dot.

The T460HW04 V0 has been designed to apply the 10-bit 4 channel LVDS interface method. It is intended to support displays where high brightness, wide viewing angle, high color saturation, and high color depth are very important.

* General Information

| Items | Specification | Unit | Note |
|------------------------|------------------------------|--------|--------------------------------|
| Active Screen Size | 46.00 | inch | |
| Display Area | 1018.08(H) x 572.67(V) | mm | |
| Outline Dimension | 1076.5(H) x 634.7(V) x 23(D) | mm | D : Front bezel to T-CON cover |
| Driver Element | a-Si TFT active matrix | | |
| Display Colors | 10 bit(8+FRC), 1073.7M | Colors | |
| Number of Pixels | 1,920x1080 | Pixel | |
| Pixel Pitch | 0.21 (H) x 0.63(W) | mm | |
| Pixel Arrangement | RGB vertical stripe | | |
| Display Operation Mode | Normally Black | | |
| Surface Treatment | Anti-Glare, 3H | | Haze=11% |

2. Absolute Maximum Ratings

The followings are maximum values which, if exceeded, may cause faulty operation or damage to the unit

| Item | Symbol | Min | Max | Unit | Conditions |
|---------------------------|--------|------|-----|--------|------------|
| Logic/LCD Drive Voltage | Vcc | -0.3 | 14 | [Volt] | Note 1 |
| Input Voltage of Signal | Vin | -0.3 | 4 | [Volt] | Note 1 |
| Operating Temperature | TOP | 0 | +50 | [°C] | Note 2 |
| Operating Humidity | HOP | 10 | 90 | [%RH] | Note 2 |
| Storage Temperature | TST | -20 | +60 | [°C] | Note 2 |
| Storage Humidity | HST | 10 | 90 | [%RH] | Note 2 |
| Panel Surface Temperature | PST | | 65 | [°C] | Note 3 |

Note 1: Duration:50 msec.

Note 2 : Maximum Wet-Bulb should be 39°C and No condensation.

The relative humidity must not exceed 90% non-condensing at temperatures of 40°C or less. At temperatures greater than 40°C, the wet bulb temperature must not exceed 39°C.

Note 3: Surface temperature is measured at 50°C Dry condition

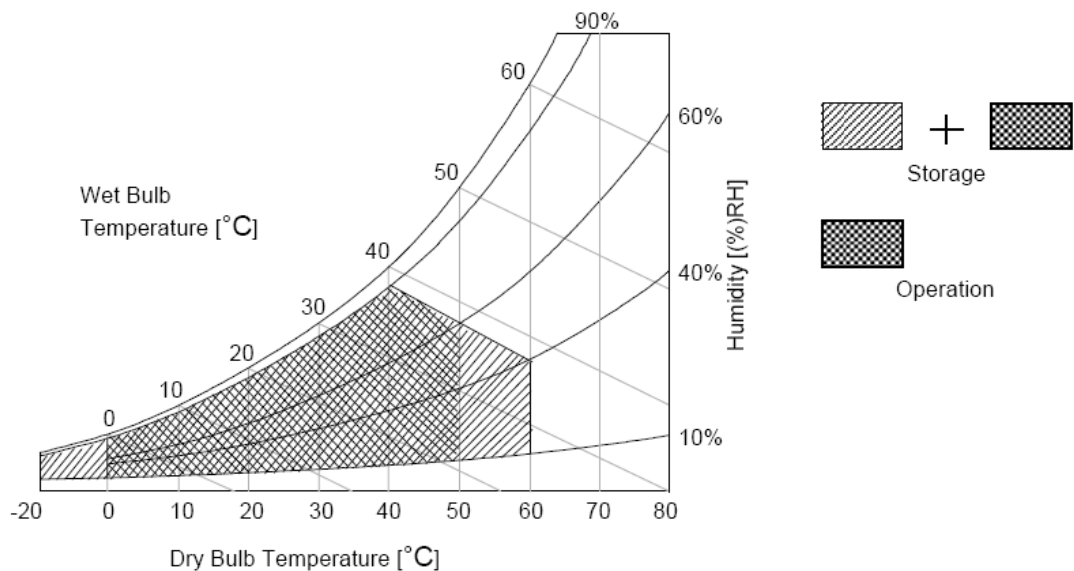

3. Electrical Specification

The T460HW04 V0 requires two power inputs. One is employed to power the LCD electronics and to drive the TFT array and liquid crystal. The second is employed for LED lightbar.

3.1 Electrical Characteristics

| Parameter | | Symbol | Value | | | Unit | Note |
|-----------------------------|---|--------------------|--------|------|------|-----------|------|
| | | | Min. | Typ. | Max | | |
| LCD | | | | | | | |
| Power Supply Input Voltage | | V_{DD} | 10.8 | 12 | 13.2 | V_{DC} | 1 |
| Power Supply Input Current | | I_{DD} | - | 0.9 | 1.2 | A | 2 |
| Power Consumption | | P_C | TBD | 10.8 | TBD | Watt | 2 |
| Inrush Current | | I_{RUSH} | - | - | 4 | A | 3 |
| LVDS Interface | Differential Input High Threshold Voltage | V_{TH} | -- | -- | +100 | mV_{DC} | 4 |
| | Differential Input Low Threshold Voltage | V_{TL} | -100 | -- | -- | mV_{DC} | 4 |
| | Input Common Mode Voltage | V_{ICM} | 1.1 | 1.25 | 1.4 | V_{DC} | 4 |
| LVDS Interface | Input Channel Pair Skew Margin | $t_{SKEW (CP)}$ | -500 | -- | +500 | ps | 5 |
| CMOS Interface | Input High Threshold Voltage | V_{IH} (High) | 2.7 | -- | 3.3 | V_{DC} | |
| | Input Low Threshold Voltage | V_{IL} (Low) | 0 | -- | 0.6 | V_{DC} | |
| Backlight Power Consumption | | P_{BL} | -- | 112 | -- | Watt | |
| Life Time | | | 30,000 | | -- | Hours | 8 |

Note :

1. The ripple voltage should be controlled under 10% of V_{CC}
2. Test Condition:
 - (1) $V_{DD} = 12.0V$
 - (2) $F_v =$ Type Timing, 60Hz, 120Hz or Other
 - (3) $F_{CLK} =$ Max freq.
 - (4) Temperature = 25 °C
 - (5) Test Pattern : White Pattern

3. Measurement condition : Rising time = 400us

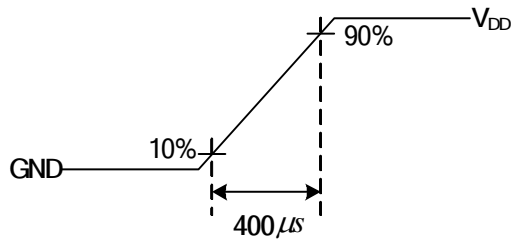

4. V_{ICM} = 1.25V

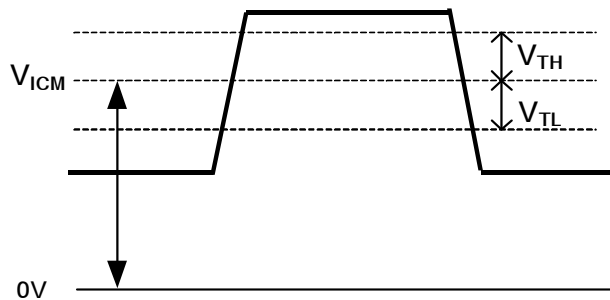

5. Input Channel Pair Skew Margin

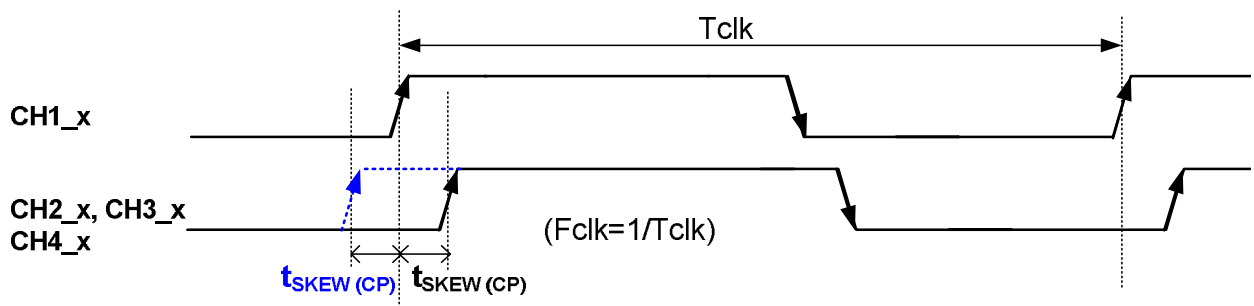

6. Do not attach a conducting tape to lamp connecting wire. If the lamp wire attach to conducting tape, TFT-LCD Module have a low luminance and the inverter has abnormal action because leakage current occurs between lamp wire and conducting tape.
7. The relative humidity must not exceed 80% non-condensing at temperatures of 40°C or less. At temperatures greater than 40°C, the wet bulb temperature must not exceed 39°C. When operate at low temperatures, the brightness of LED will drop and the life time of LED will be reduced.
8. The lifetime is defined as the time which luminance of the LED is 50% compared to its original value.
[Operating condition: Continuous operating at Ta = 25±2°C]

3.2 Interface Connections

- LCD connector: JAE FI-RE51S-HF
- Mating connector :

| PIN | Symbol | Description | PIN | Symbol | Description |
|-----|----------|---|-----|-----------------|---------------------------------|
| 1 | Reserved | AUO Internal Use Only | 26 | GND | Ground |
| 2 | Reserved | AUO Internal Use Only | 27 | GND | Ground |
| 3 | NC | No connection | 28 | CH2_0- | LVDS Channel 2, Signal 0- |
| 4 | Reserved | AUO Internal Use Only | 29 | CH2_0+ | LVDS Channel 2, Signal 0+ |
| 5 | NC | No connection | 30 | CH2_1- | LVDS Channel 2, Signal 1- |
| 6 | NC | No connection | 31 | CH2_1+ | LVDS Channel 2, Signal 1+ |
| 7 | LVDS_SEL | Open/High(3.3V) for NS, Low(GND) for JEIDA | 32 | CH2_2- | LVDS Channel 2, Signal 2- |
| 8 | Reserved | AUO Internal Use Only | 33 | CH2_2+ | LVDS Channel 2, Signal 2+ |
| 9 | Reserved | AUO Internal Use Only | 34 | GND | Ground |
| 10 | Reserved | AUO Internal Use Only | 35 | CH2_CLK- | LVDS Channel 2, Clock - |
| 11 | GND | Ground | 36 | CH2_CLK+ | LVDS Channel 2, Clock + |
| 12 | CH1_0- | LVDS Channel 1, Signal 0- | 37 | GND | Ground |
| 13 | CH1_0+ | LVDS Channel 1, Signal 0+ | 38 | CH2_3- | LVDS Channel 2, Signal 3- |
| 14 | CH1_1- | LVDS Channel 1, Signal 1- | 39 | CH2_3+ | LVDS Channel 2, Signal 3+ |
| 15 | CH1_1+ | LVDS Channel 1, Signal 1+ | 40 | CH2_4- | LVDS Channel 2, Signal 4- |
| 16 | CH1_2- | LVDS Channel 1, Signal 2- | 41 | CH2_4+ | LVDS Channel 2, Signal 4+ |
| 17 | CH1_2+ | LVDS Channel 1, Signal 2+ | 42 | GND | Ground |
| 18 | GND | Ground | 43 | GND | Ground |
| 19 | CH1_CLK- | LVDS Channel 1, Clock - | 44 | GND | Ground |
| 20 | CH1_CLK+ | LVDS Channel 1, Clock + | 45 | GND | Ground |
| 21 | GND | Ground | 46 | GND | Ground |
| 22 | CH1_3- | LVDS Channel 1, Signal 3- | 47 | NC | No connection |
| 23 | CH1_3+ | LVDS Channel 1, Signal 3+ | 48 | V _{DD} | Power Supply, +12V DC Regulated |
| 24 | CH1_4- | LVDS Channel 1, Signal 4- | 49 | V _{DD} | Power Supply, +12V DC Regulated |
| 25 | CH1_4+ | LVDS Channel 1, Signal 4+ | 50 | V _{DD} | Power Supply, +12V DC Regulated |
| | | | 51 | V _{DD} | Power Supply, +12V DC Regulated |

- LCD connector: JAE FI-RE41S-HF
- Mating connector:

| PIN | Symbol | Description | PIN | Symbol | Description |
|-----|----------|---------------------------|-----|----------|---------------------------|
| 1 | NC | No connection | 21 | CH3_3+ | LVDS Channel 3, Signal 3+ |
| 2 | Reserved | AUO Internal Use Only | 22 | CH3_4- | LVDS Channel 3, Signal 4- |
| 3 | Reserved | AUO Internal Use Only | 23 | CH3_4+ | LVDS Channel 3, Signal 4+ |
| 4 | NC | No connection | 24 | GND | Ground |
| 5 | Reserved | AUO Internal Use Only | 25 | GND | Ground |
| 6 | Reserved | AUO Internal Use Only | 26 | CH4_0- | LVDS Channel 4, Signal 0- |
| 7 | NC | No connection | 27 | CH4_0+ | LVDS Channel 4, Signal 0+ |
| 8 | NC | No connection | 28 | CH4_1- | LVDS Channel 4, Signal 1- |
| 9 | GND | Ground | 29 | CH4_1+ | LVDS Channel 4, Signal 1+ |
| 10 | CH3_0- | LVDS Channel 3, Signal 0- | 30 | CH4_2- | LVDS Channel 4, Signal 2- |
| 11 | CH3_0+ | LVDS Channel 3, Signal 0+ | 31 | CH4_2+ | LVDS Channel 4, Signal 2+ |
| 12 | CH3_1- | LVDS Channel 3, Signal 1- | 32 | GND | Ground |
| 13 | CH3_1+ | LVDS Channel 3, Signal 1+ | 33 | CH4_CLK- | LVDS Channel 4, Clock - |
| 14 | CH3_2- | LVDS Channel 3, Signal 2- | 34 | CH4_CLK+ | LVDS Channel 4, Clock + |
| 15 | CH3_2+ | LVDS Channel 3, Signal 2+ | 35 | GND | Ground |
| 16 | GND | Ground | 36 | CH4_3- | LVDS Channel 4, Signal 3- |
| 17 | CH3_CLK- | LVDS Channel 3, Clock - | 37 | CH4_3+ | LVDS Channel 4, Signal 3+ |
| 18 | CH3_CLK+ | LVDS Channel 3, Clock + | 38 | CH4_4- | LVDS Channel 4, Signal 4- |
| 19 | GND | Ground | 39 | CH4_4+ | LVDS Channel 4, Signal 4+ |
| 20 | CH3_3- | LVDS Channel 3, Signal 3- | 40 | GND | Ground |
| | | | 41 | GND | Ground |

LVDS Option = High/Open→NS

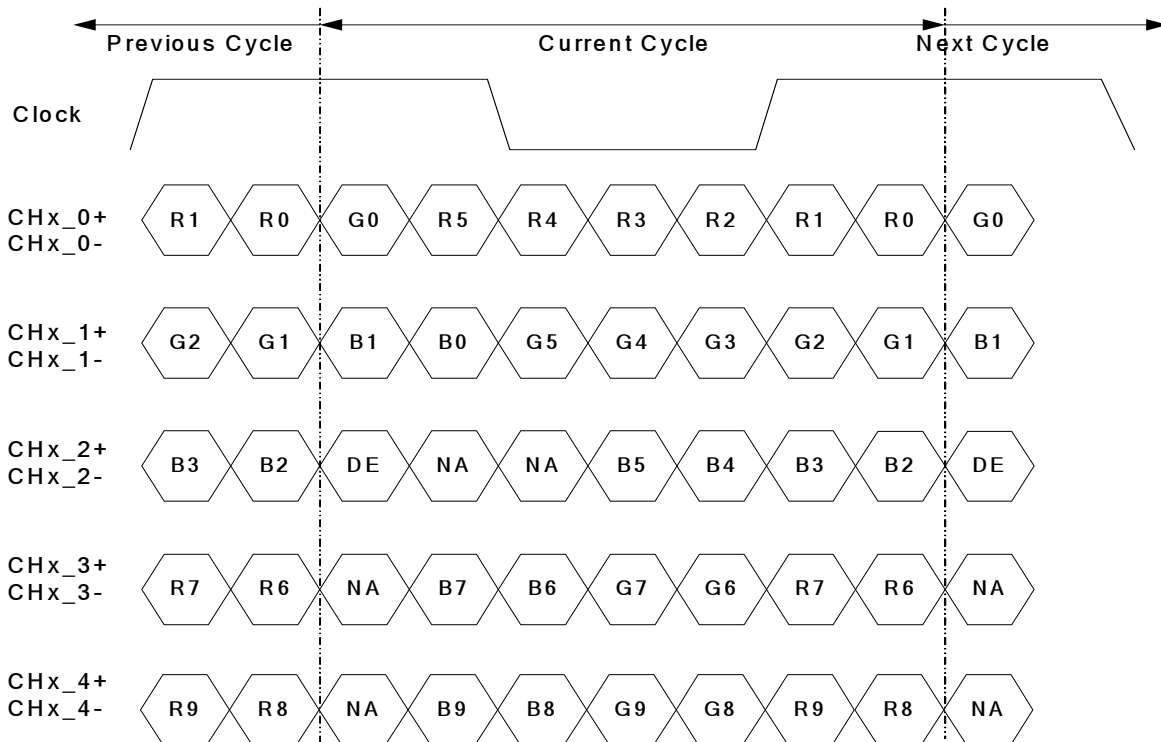

Note: x = 1, 2, 3, 4...

LVDS Option = Low→JEIDA

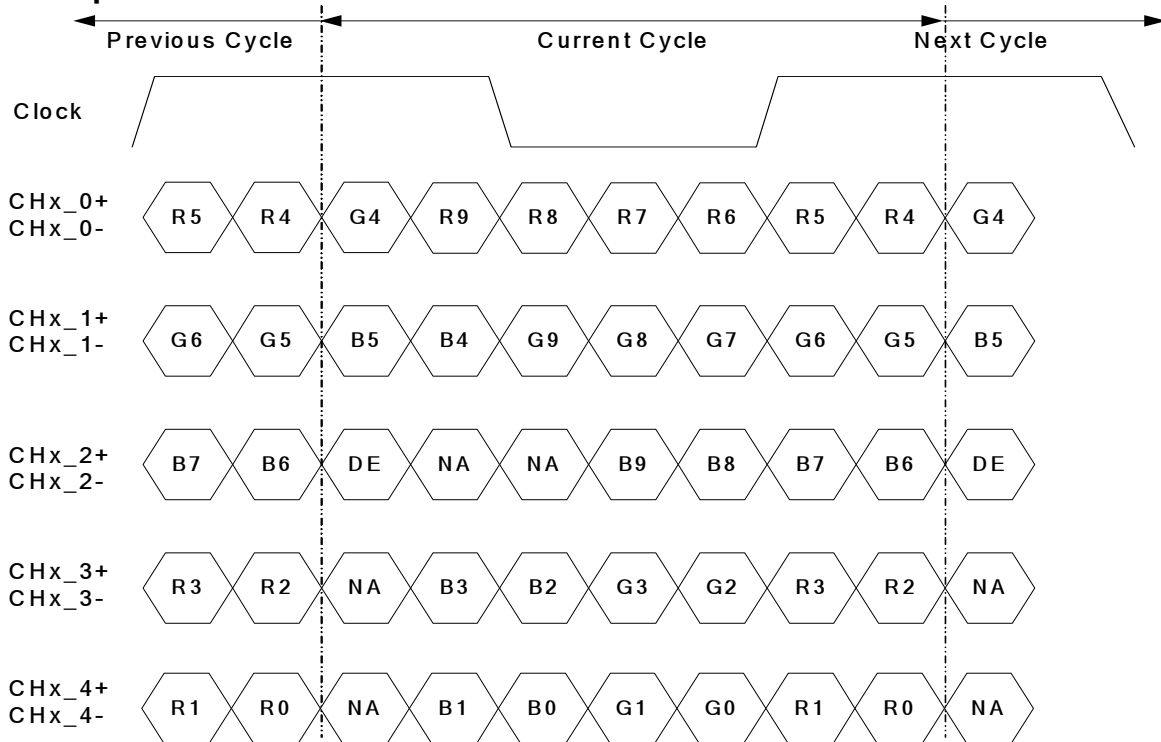

Note: x = 1, 2, 3, 4...

3.3 Signal Timing Specification

This is the signal timing required at the input of the user connector. All of the interface signal timing should be satisfied with the following specifications for its proper operation.

Timing Table

| Signal | Item | Symbol | Min. | Typ. | Max | Unit |
|----------------------|-----------|-------------|------|-------|-------|------|
| Vertical Section | Period | Tv | 1090 | 1130 | 1392 | Th |
| | Active | Tdisp (v) | 1080 | | | Th |
| | Blanking | Tblk (v) | 10 | 50 | 312 | Th |
| Horizontal Section | Period | Th | 540 | 570 | 580 | Tclk |
| | Active | Tdisp (h) | 480 | | | Tclk |
| | Blanking | Tblk (h) | 60 | 90 | 100 | Tclk |
| Clock | Frequency | Fclk=1/Tclk | 64.8 | 77.29 | 80.74 | MHz |
| Vertical Frequency | Frequency | Fv | 94 | 120 | 122 | Hz |
| Horizontal Frequency | Frequency | Fh | 120 | 135.6 | 139.2 | KHz |

Notes:

(1) Display position is specific by the rise of DE signal only.

Horizontal display position is specified by the rising edge of 1st DCLK after the rise of 1st DE, is displayed on the left edge of the screen.

(2) Vertical display position is specified by the rise of DE after a "Low" level period equivalent to eight times of horizontal period. The 1st data corresponding to one horizontal line after the rise of 1st DE is displayed at the top line of screen.

(3) If a period of DE "High" is less than 1920 DCLK or less than 1080 lines, the rest of the screen displays black.

(4) The display position does not fit to the screen if a period of DE "High" and the effective data period do not synchronize with each other.

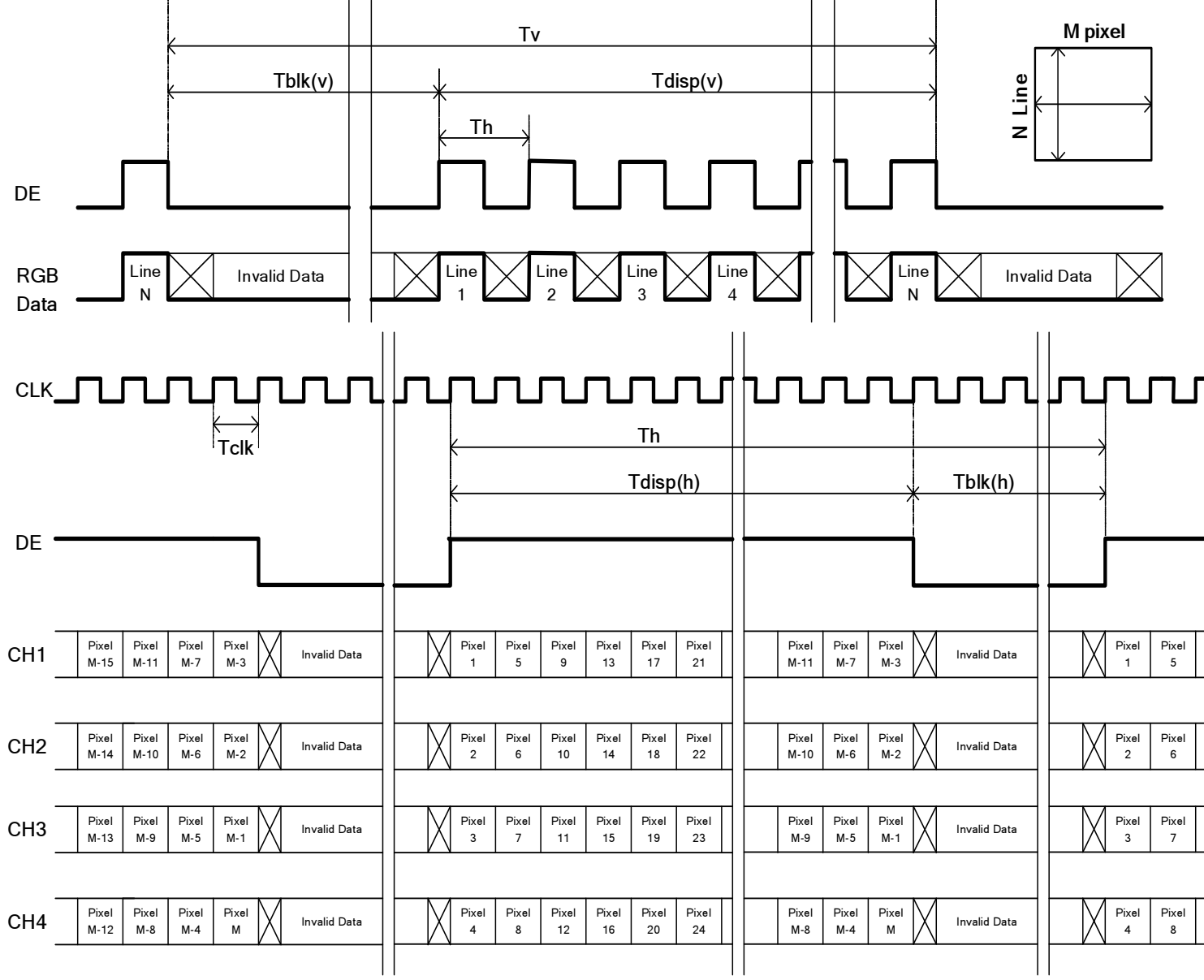
3.4 Signal Timing Waveforms

3.6 Power Sequence for LCD

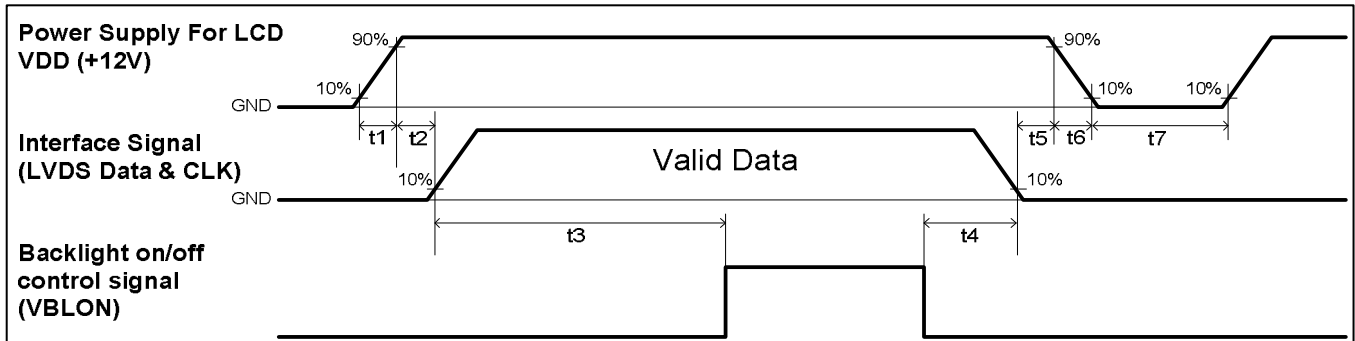

| Parameter | Values | | | Unit |
|-----------|-----------------|-------|-------------------|------|
| | Min. | Type. | Max. | |
| t1 | 0.4 | --- | 30 | ms |
| t2 | 0.1 | --- | --- | ms |
| t3 | 300 | --- | --- | ms |
| t4 | 0 ^{*1} | --- | --- | ms |
| t5 | 0 | --- | --- | ms |
| t6 | --- | --- | --- ^{*2} | ms |
| t7 | 500 | --- | --- | ms |

Note:

- (1) T4=0 : concern for residual pattern before BLU turn off.
- (2) T6 : voltage of VDD must decay smoothly after power-off. (customer system decide this value)

3.7 Backlight Specification

The backlight unit contains 4pcs LED lightbar

3.7.1 Electrical specification

| | Item | Symbol | Condition | Spec | | | Unit | Note | |
|----|------------------------------|------------------------------|-----------------------|-----------------------|------|------|------|------|---|
| | | | | Min | Typ | Max | | | |
| 1 | Input Voltage | V _{DDB} | - | 21.6 | 24 | 26.4 | VDC | - | |
| 2 | Input Current | I _{DDB} | V _{DDB} =24V | 4 | 4.65 | 5.7 | ADC | 1 | |
| 3 | Input Power | P _{DDB} | V _{DDB} =24V | - | 112 | 136 | W | 1 | |
| 4 | Inrush Current | I _{RUSH} | V _{DDB} =24V | - | - | 7 | ADC | 2 | |
| 5 | On/Off control voltage | V _{B_{LON}} | ON | V _{DDB} =24V | 2 | - | 5.5 | VDC | - |
| | | | OFF | | 0 | - | 0.8 | | - |
| 6 | On/Off control current | I _{B_{LON}} | V _{DDB} =24V | - | - | 1.5 | mA | - | |
| 7 | Dimming Control Voltage | V _{DIM} | MAX | V _{DDB} =24V | 3.0 | - | 3.3 | VDC | - |
| | | | MIN | | - | 0 | - | VDC | - |
| 8 | Dimming Control Current | I _{DIM} | V _{DDB} =24V | - | - | 2 | mADC | - | |
| 9 | Internal Dimming Ratio | DIM _R | V _{DDB} =24V | 20 | - | 100 | % | 3 | |
| 10 | External PWM Control Voltage | V _{EPWM} | MAX | V _{DDB} =24V | 2 | - | 3.3 | VDC | - |
| | | | MIN | V _{DDB} =24V | 0 | - | 0.8 | | - |
| 11 | External PWM Control Current | I _{EPWM} | V _{DDB} =24V | - | - | 2 | mADC | - | |
| 12 | External PWM Duty ratio | D _{EPWM} | V _{DDB} =24V | 10 | - | 100 | % | 3 | |
| 13 | External PWM Frequency | F _{EPWM} | V _{DDB} =24V | 140 | 180 | 240 | Hz | - | |

Note 1 : Dimming ratio= 100% (MAX) (Ta=25±5°C , Turn on for 45minutes)

Note 2: Measurement condition Rising time = 20ms (V_{DDB} : 10%~90%);

Note 3: Less than10% dimming control is functional well and no backlight shutdown happened

3.7.2 Input Pin Assignment

LED driver board connector : **CI0114M1HR0-NH**

| Pin | Symbol | Description |
|-----|----------|--|
| 1 | VDDB | Operating Voltage Supply, +24V DC regulated |
| 2 | VDDB | Operating Voltage Supply, +24V DC regulated |
| 3 | VDDB | Operating Voltage Supply, +24V DC regulated |
| 4 | VDDB | Operating Voltage Supply, +24V DC regulated |
| 5 | VDDB | Operating Voltage Supply, +24V DC regulated |
| 6 | BLGND | Ground and Current Return |
| 7 | BLGND | Ground and Current Return |
| 8 | BLGND | Ground and Current Return |
| 9 | BLGND | Ground and Current Return |
| 10 | BLGND | Ground and Current Return |
| 11 | DET | BLU status detection: Normal : 0~0.8V ; Abnormal : Open collector |
| 12 | VBLOn | BLU On-Off control: High/Open (3.3V) : BL On ; Low (-0.3~0.8V/GND) : BL Off |
| 13 | VDIM(**) | Internal PWM (0~3.3V for 20~100% Duty, open for 100%) < NC ; at External PWM mode > |
| 14 | PDIM(*) | External PWM (10%~100% Duty, open for 100%) < NC ; at Internal PWM mode > |

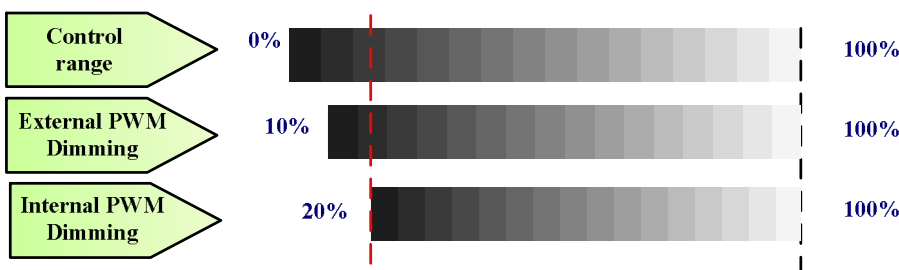

PWM Dimming : include Internal and External PWM Dimming

(Note*) IF External PWM function includes 10% dimming ratio. Judge condition as below:

- (1) Backlight module must be lighted ON normally.
- (2) All protection function must work normally.
- (3) Uniformity and flicker could NOT be guaranteed

4. Optical Specification

Optical characteristics are determined after the unit has been 'ON' and stable for approximately 45 minutes in a dark environment at 25°C. The values specified are at an approximate distance 50cm from the LCD surface at a viewing angle of φ and θ equal to 0°.

Fig.1 presents additional information concerning the measurement equipment and method.

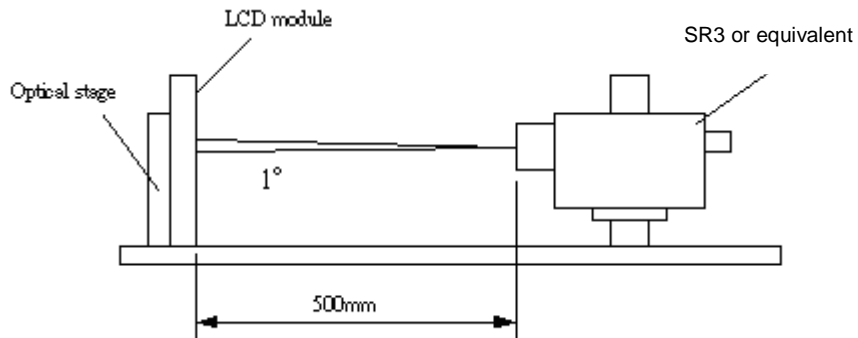

| Parameter | Symbol | Values | | | Unit | Notes |
|---------------------------|--------------------------------------|----------------|-----------|-------|-------------------|--------|
| | | Min. | Typ. | Max | | |
| Contrast Ratio | CR | 3200 | 4000 | -- | | 1 |
| Surface Luminance (White) | L _{WH} | 360 | 450 | -- | cd/m ² | 2 |
| Luminance Variation | $\delta_{\text{WHITE}(9P)}$ | -- | -- | 1.3 | | 3 |
| Response Time (G to G) | T _γ | -- | 5.5 | -- | Ms | 4 |
| Color Gamut | NTSC | | 72 | | % | |
| Color Coordinates | | | | | | |
| | Red | R _X | Typ.-0.03 | 0.640 | Typ.+0.03 | |
| | | R _Y | | 0.330 | | |
| | Green | G _X | | 0.281 | | |
| | | G _Y | | 0.590 | | |
| | Blue | B _X | | 0.144 | | |
| | | B _Y | | 0.060 | | |
| | White | W _X | | 0.280 | | |
| | W _Y | 0.290 | | | | |
| Viewing Angle | | | | | | |
| | x axis, right($\varphi=0^\circ$) | θ_r | -- | 89 | -- | degree |
| | x axis, left($\varphi=180^\circ$) | θ_l | -- | 89 | -- | degree |
| | y axis, up($\varphi=90^\circ$) | θ_u | -- | 89 | -- | degree |
| | y axis, down ($\varphi=270^\circ$) | θ_d | -- | 89 | -- | degree |

Note:

1. Contrast Ratio (CR) is defined mathematically as:

$$\text{Contrast Ratio} = \frac{\text{Surface Luminance of } L_{on5}}{\text{Surface Luminance of } L_{off5}}$$

2. Surface luminance is luminance value at point 5 across the LCD surface 50cm from the surface with all pixels displaying white. From more information see FIG 2. When lamp current $I_H = 11\text{mA}$. $L_{WH} = L_{on5}$ where L_{on5} is the luminance with all pixels displaying white at center 5 location.

3. The variation in surface luminance, δ_{WHITE} is defined (center of Screen) as:

$$\delta_{WHITE(9P)} = \frac{\text{Maximum}(L_{on1}, L_{on2}, \dots, L_{on9})}{\text{Minimum}(L_{on1}, L_{on2}, \dots, L_{on9})}$$

4. Response time T_γ is the average time required for display transition by switching the input signal for five luminance ratio (0%,25%,50%,75%,100% brightness matrix) and is based on $F_v = 60\text{Hz}$ to optimize.

| Measured Response Time | | Target | | | | |
|------------------------|------|------------|-------------|-------------|-------------|-------------|
| | | 0% | 25% | 50% | 75% | 100% |
| Start | 0% | | 0% to 25% | 0% to 50% | 0% to 75% | 0% to 100% |
| | 25% | 25% to 0% | | 25% to 50% | 25% to 75% | 25% to 100% |
| | 50% | 50% to 0% | 50% to 25% | | 50% to 75% | 50% to 100% |
| | 75% | 75% to 0% | 75% to 25% | 75% to 50% | | 75% to 100% |
| | 100% | 100% to 0% | 100% to 25% | 100% to 50% | 100% to 75% | |

4. Viewing angle is the angle at which the contrast ratio is greater than 10. The angles are determined for the horizontal or x axis and the vertical or y axis with respect to the z axis which is normal to the LCD surface. For more information see FIG4.

FIG. 2 Luminance

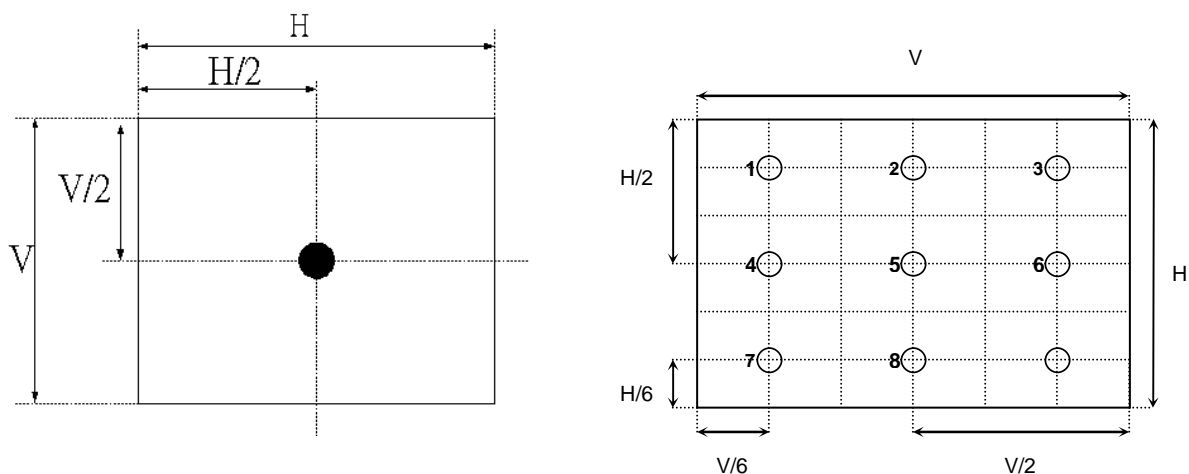

FIG.3 Response Time

The response time is defined as the following figure and shall be measured by switching the input signal for “any level of gray(bright) “ and “any level of gray(dark)”.

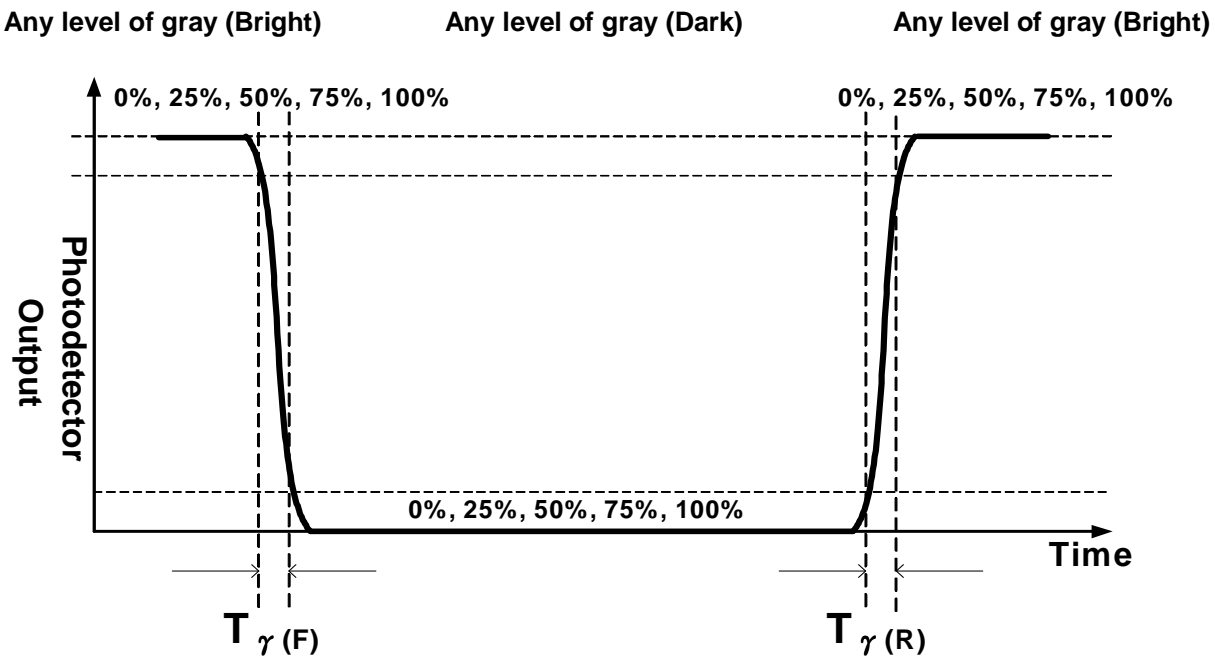
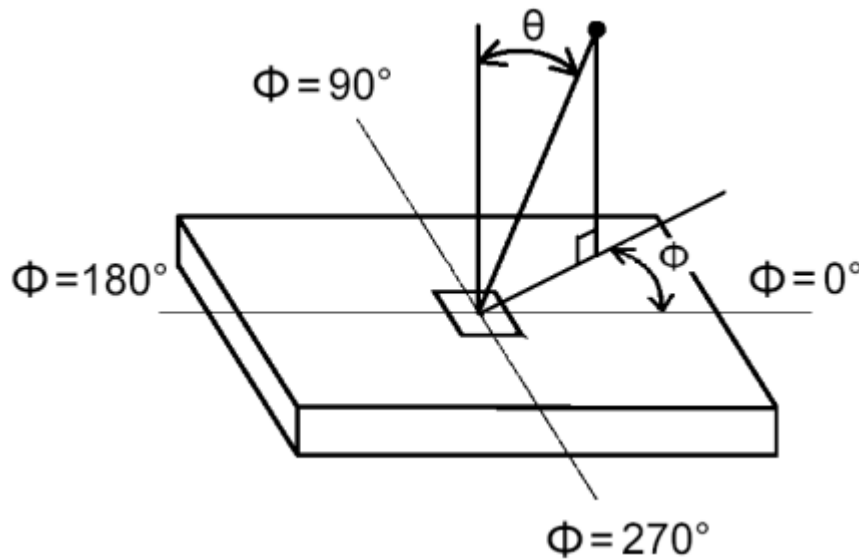

FIG.4 Viewing Angle



5. Mechanical Characteristics

The contents provide general mechanical characteristics for the model T460HW04 V1. In addition the figures in the next page are detailed mechanical drawing of the LCD.

| | | |
|---------------------|-----------------|------------------------------------|
| Outline Dimension | Horizontal | 1076.5 mm |
| | Vertical | 634.7 mm |
| | Depth | 23 mm (Front bezel to T-CON cover) |
| Bezel Opening | Horizontal | 1024.5 mm |
| | Vertical | 578.7 mm |
| Active Display Area | Horizontal | 1018.08 mm |
| | Vertical | 572.67 mm |
| Weight | 10,500 g (Typ.) | |
| Surface Treatment | Anti-Glare, 3H | |

6. Reliability Test Items

| | Test Item | Q'ty | Condition |
|---|---------------------------------|---------|--|
| 1 | High temperature storage test | 3 | 60°C, 300hrs |
| 2 | Low temperature storage test | 3 | -20°C, 300hrs |
| 3 | High temperature operation test | 3 | 50°C, 300hrs |
| 4 | Low temperature operation test | 3 | -5°C, 300hrs |
| 5 | Vibration test (non-operation) | 3 | Wave form: random Vibration level: 1.5G RMS Bandwidth: 10-300Hz, Duration: X, Y, Z 30min One time each direction |
| 6 | Shock test (non-operation) | 3 | Shock level: 30G Waveform: half sine wave, 11ms Direction: ±X, ±Y, ±Z, One time each direction |
| 7 | Vibration test (With carton) | 1 (PKG) | Random wave (1.5G RMS, 10-200Hz) 30mins/ Per each X,Y,Z axes |
| 8 | Drop test (With carton) | 1 (PKG) | Surround four flats drop height : 15 cm Bottom flat drop height:25.4 cm twice (ASTMD4169) |

7. International Standard

7.1 Safety

- (1) UL 60950-1, UL 60065; Standard for Safety of Information Technology Equipment Including electrical Business Equipment.
- (2) IEC 60950-1 : 2001, IEC 60065:2001 ; Standard for Safety of International Electrotechnical Commission
- (3) EN 60950 : 2001+A11, EN 60065:2002+A1:2006; European Committee for Electrotechnical Standardization (CENELEC), EUROPEAN STANDARD for Safety of Information Technology Equipment Including Electrical Business Equipment.

7.2 EMC

- (1) ANSI C63.4 "Methods of Measurement of Radio-Noise Emissions from Low-Voltage Electrical and Electrical Equipment in the Range of 9kHz to 40GHz. "American National standards Institute(ANSI), 1992
- (2) C.I.S.P.R "Limits and Methods of Measurement of Radio Interface Characteristics of Information Technology Equipment." International Special committee on Radio Interference.
- (3) EN 55022 "Limits and Methods of Measurement of Radio Interface Characteristics of Information Technology Equipment." European Committee for Electrotechnical Standardization. (CENELEC), 1998



8. Packing

8-1 DEFINITION OF LABEL:

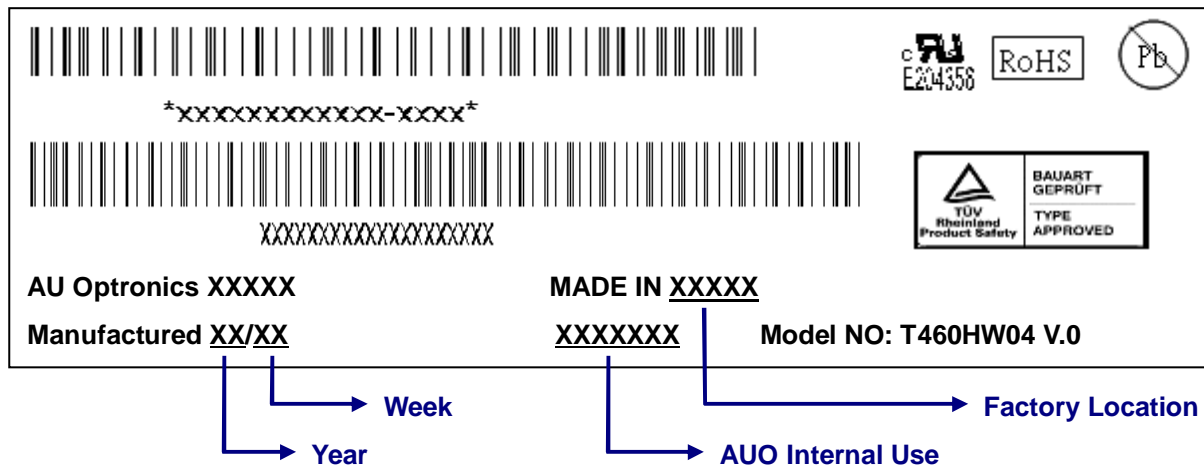
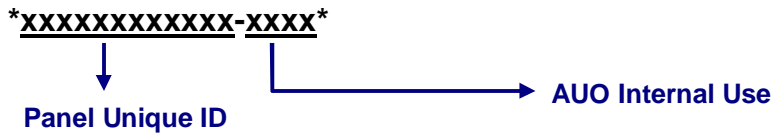
A. Panel Label:



Green mark description

- (1) For Pb Free Product, AUO will add  for identification.
 - (2) For RoHs compatible products, AUO will add  for identification.
- Note: The green Mark will be present only when the green documents have been ready by AUO internal green team. (definition of green design follows the AUO green design checklist.)

B. Carton Label:

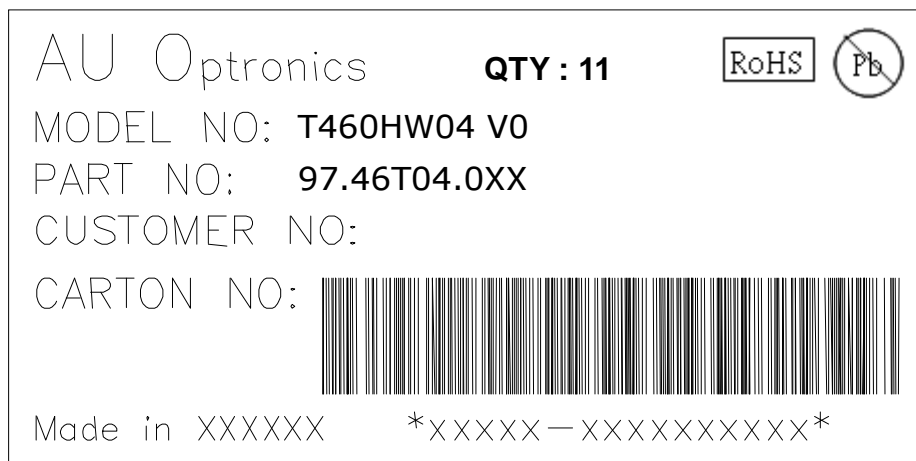

8-2 PACKING METHODS:

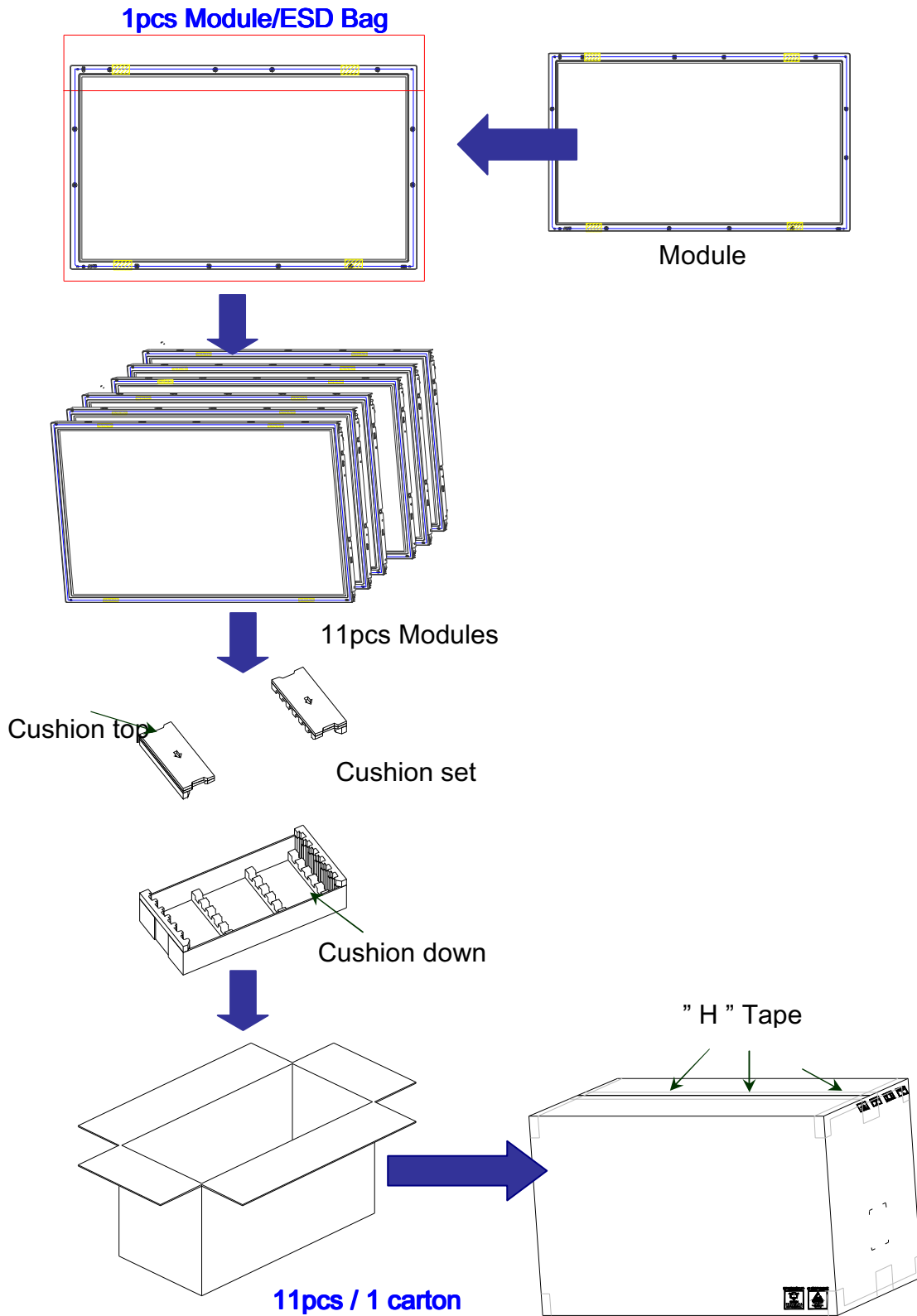

8-3 Pallet and Shipment Information

| | Item | Specification | | | Packing Remark |
|---|----------------------|----------------|------------------------|-------------|----------------|
| | | Qty. | Dimension | Weight (kg) | |
| 1 | Packing BOX | 11pcs/box | 1160(L)*552(W)*685(H) | 128 | |
| 2 | Pallet | 1 | 1180(L)*1150(W)*132(H) | 17.5 | |
| 3 | Boxes per Pallet | 2 boxes/pallet | | | |
| 4 | Panels per Pallet | 22pcs/pallet | | | |
| | Pallet after packing | 22pcs | 1180(L)*1150(W)*817(H) | 273.5 | |

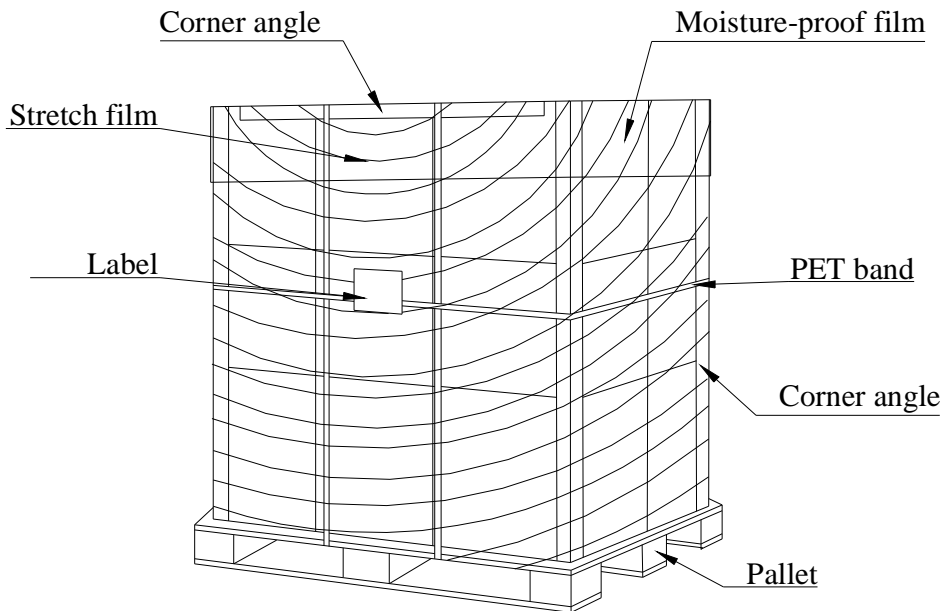

9. PRECAUTIONS

Please pay attention to the followings when you use this TFT LCD module.

9-1 MOUNTING PRECAUTIONS

- (1) You must mount a module using holes arranged in four corners or four sides.
- (2) You should consider the mounting structure so that uneven force (ex. twisted stress) is not applied to module. And the case on which a module is mounted should have sufficient strength so that external force is not transmitted directly to the module.
- (3) Please attach the surface transparent protective plate to the surface in order to protect the polarizer. Transparent protective plate should have sufficient strength in order to resist external force.
- (4) You should adopt radiation structure to satisfy the temperature specification.
- (5) Acetic acid type and chlorine type materials for the cover case are not desirable because the former generates corrosive gas of attacking the polarizer at high temperature and the latter cause circuit broken by electro-chemical reaction.
- (6) Do not touch, push or rub the exposed polarizer with glass, tweezers or anything harder than HB pencil lead. And please do not rub with dust clothes with chemical treatment. Do not touch the surface of polarizer for bare hand or greasy cloth. (Some cosmetics are detrimental to the polarizer.)
- (7) When the surface becomes dusty, please wipe gently with absorbent cotton or other soft materials like chamois soaks with petroleum benzene. Normal-hexane is recommended for cleaning the adhesives used to attach front/ rear polarizer. Do not use acetone, toluene and alcohol because they cause chemical damage to the polarizer.
- (8) Wipe off saliva or water drops as soon as possible. Their long time contact with polarizer causes deformations and color fading.
- (9) Do not open the case because inside circuits do not have sufficient strength.

9-2 OPERATING PRECAUTIONS

- (1) The device listed in the product specification sheets was designed and manufactured for TV application
- (2) The spike noise causes the mis-operation of circuits. It should be lower than following voltage:
 $V=\pm 200\text{mV}$ (Over and under shoot voltage)
- (3) Response time depends on the temperature. (In lower temperature, it becomes longer..)
- (4) Brightness of CCFL depends on the temperature. (In lower temperature, it becomes lower.) And in lower temperature, response time (required time that brightness is stable after turned on) becomes longer.
- (5) Be careful for condensation at sudden temperature change. Condensation makes damage to polarizer or electrical contacted parts. And after fading condensation, smear or spot will occur.
- (6) When fixed patterns are displayed for a long time, remnant image is likely to occur.
- (7) Module has high frequency circuits. Sufficient suppression to the electromagnetic interference shall

be done by system manufacturers. Grounding and shielding methods may be important to minimize the interface.

9-3 ELECTROSTATIC DISCHARGE CONTROL

Since a module is composed of electronic circuits, it is not strong to electrostatic discharge. Make certain that treatment persons are connected to ground through wristband etc. And don't touch interface pin directly.

9-4 PRECAUTIONS FOR STRONG LIGHT EXPOSURE

Strong light exposure causes degradation of polarizer and color filter.

9-5 STORAGE

When storing modules as spares for a long time, the following precautions are necessary.

- (1) Store them in a dark place. Do not expose the module to sunlight or fluorescent light. Keep the temperature between 5°C and 35°C at normal humidity.
- (2) The polarizer surface should not come in contact with any other object. It is recommended that they be stored in the container in which they were shipped.

9-6 HANDLING PRECAUTIONS FOR PROTECTION FILM

- (1) The protection film is attached to the bezel with a small masking tape. When the protection film is peeled off, static electricity is generated between the film and polarizer. This should be peeled off slowly and carefully by people who are electrically grounded and with well ion-blown equipment or in such a condition, etc.
- (2) When the module with protection film attached is stored for a long time, sometimes there remains a very small amount of glue still on the bezel after the protection film is peeled off.
- (3) You can remove the glue easily. When the glue remains on the bezel or its vestige is recognized, please wipe them off with absorbent cotton waste or other soft material like chamois soaked with normal-hexane.