

LCD Module Technical Specification

First Edition
Feb 23, 2007

Final Revision

Type No.

T-55225D104J-FW-A-AAN

OPTREX CORPORATION

Shigeo Suzuki

Approved : *QUALITY ASSURANCE DIVISION*

Toshiyuki Okamoto _____

Checked : *MOBILE, CONSUMER & INDUSTRY DESIGN DIV.*

Takashi Yuchi _____

Prepared : *MOBILE, CONSUMER & INDUSTRY DESIGN DIV.*

APPROVED

By _____

Signature :

Date :

Please return this specification within two month with your signature.
If not returned within two month ,specification will be considered
as having been accepted.

Table of Contents

No.	Item	Page
--	CONTENTS	2
1	APPLICATION	3
2	OVERVIEW	4
3	ABSOLUTE MAXIMUM RATINGS	5
4	ELECTRICAL CHARACTERISTICS	5
5	INTERFACE PIN CONNECTION	8
6	INTERFACE TIMING	9
7	BLOCK DIAGRAM	13
8	MECHANICAL SPECIFICATION	14
9	OPTICAL CHARACTERISTICS	16
10	RELIABILITY TEST CONDITION	19
11	INSPECTION STANDARDS	20
12	OTHER FEATURE	21
13	HANDLING PRECAUTIONS FOR TFT-LCD MODULE	22
--	PACKAGING SPECIFICATION	25
--	PRODUCTS NUMBER LABELING FORMS	28
--	LAMP UNIT for 10.4" XGA	30

Revision History

Rev.	Date	Page	Comment

1. APPLICATION

This specification applies to color TFT-LCD module, T-55225D104J-FW-A-AAN.

These specification papers are the proprietary product of OPTREX and include materials protected under copyright of OPTREX. No part of this document may be reproduced in any form or by any means without the express written permission of OPTREX.

OPTREX does not assume any liability for infringement of patents, copyrights or other intellectual property rights of third parties by or arising from use of a product specified in this document. No license, express, implied or otherwise, is granted under any patents, copyrights or other intellectual property rights of OPTREX or of others.

OPTREX classifies the usage of the TFT-LCD module as follows. Please confirm the usage before using the product.

(1) Standard Usage

Computers, office equipment, factory automation equipment, test and measurement equipment, communications, transportation equipment(automobiles, ships, trains, etc.), provided, however, that operation is not influenced by TFT-LCD directly.

(2) Special Usage

Medical equipment, safety equipment, transportation equipment, provided, however, that TFT-LCD is necessary to its operation.

(3) Specific Usage

Cockpit Equipment, military systems, aerospace equipment, nuclear reactor control systems, life support systems and any other equipment. OPTREX should make a contract that stipulate apportionment of responsibilities between OPTREX and our customer.

The product specified in this document is designed for "Standard Usage" unless otherwise specified in this document. If customers intend to use the product for applications other than those specified for "Standard Usage", they should contact OPTREX sales representative in advance.

OPTREX has been making continuous effort to improve the reliability of its products. Customers should implement sufficient reliability design of their application equipments such as redundant system design, fail-safe functions, anti-failure features.

OPTREX assumes no responsibility for any damage resulting from the use of the product that does not comply with the instructions and the precautions specified in this document.

Please contact and consult a OPTREX sales representative for any questions regarding this product.

2. OVERVIEW

T-55225D104J-FW-A-AAN is 10.4" color TFT-LCD (Thin Film Transistor Liquid Crystal Display) module composed of LCD panel, driver ICs, control circuit, and backlight unit.

By applying 6 bit or 8 bit digital data, 1024 × 768, 262k-color or 16.7M-color images are displayed on the 10.4" diagonal screen. Input power voltage is 3.3 V for LCD driving.

The type of data and control signals are digital and transmitted via LVDS interface per Typ. 65 MHz clock cycle.

Inverter for backlight is not included in this module. General specifications are summarized in the following table:

ITEM	SPECIFICATION
Display Area (mm)	210.4 (H) × 157.8 (V) (10.4-inch diagonal)
Number of Dots	1024 × 3 (H) × 768 (V)
Pixel Pitch (mm)	0.2055 (H) × 0.2055 (V)
Color Pixel Arrangement	RGB vertical stripe
Display Mode	Normally white TN
Number of Color	262k(6 bit/color) 16.7M(8 bit/color)
Luminance (cd/m ²)	400
Wide Viewing Angle Technology	Optical Compensation Film
Viewing Angle (CR ≥ 10)	-80~80°(H) -65~65°(V)
Surface Treatment	Anti-glare and hard-coating 3H
Electrical Interface	LVDS
Optimum Viewing Angle (Contrast ratio)	6 o'clock
Module Size (mm)	230.0 (W) × 180.2 (H) × 10.5 (D)
Module Mass (g)	600
Backlight Unit	CCFL, 2-tubes, edge-light, replaceable

Characteristic value without any note is typical value.

3. ABSOLUTE MAXIMUM RATINGS

ITEM	SYMBOL	MIN.	MAX	UNIT
Power Supply Voltage for LCD	VCC	0	4.0	V
Logic Input Voltage	VI	-0.3	VCC+0.3	V
Lamp Voltage	VL	0	2000	Vrms
Lamp Current	IL	0	18	mArms
Lamp Frequency	FL	--	80	kHz
Operation Temperature (Panel) <small>Note 1,2)</small>	T _{op(Panel)}	-20	70	°C
Operation Temperature (Ambient) <small>Note 2)</small>	T _{op(Ambient)}	-20	70	°C
Storage Temperature <small>Note 2)</small>	T _{stg}	-20	80	°C

[Note]

- 1) Measured at the center of active area and at the center of panel back surface
- 2) Top, Tstg ≤ 40°C : 90%RH max. without condensation
 Top, Tstg > 40°C : Absolute humidity shall be less than the value of 90%RH at 40°C without condensation.

4. ELECTRICAL CHARACTERISTICS

(1) TFT-LCD

Ambient temperature: Ta = 25°C

ITEM	SYMBOL	MIN.	TYP.	MAX.	UNIT	Remarks	
Power Supply Voltages for LCD	VCC	3.0	3.3	3.6	V	*1)	
Power Supply Currents for LCD	ICC	--	440	800	mA	*2)	
Permissible Input Ripple Voltage	VRP	--	--	100	mVp-p	VCC = +3.3 V	
Logic Input Voltage	High	VIH	2.0	--	VCC+0.3	V	MODE, SC
	Low	VIL	0	--	0.8	V	MODE, SC

*1) Power and signals sequence:

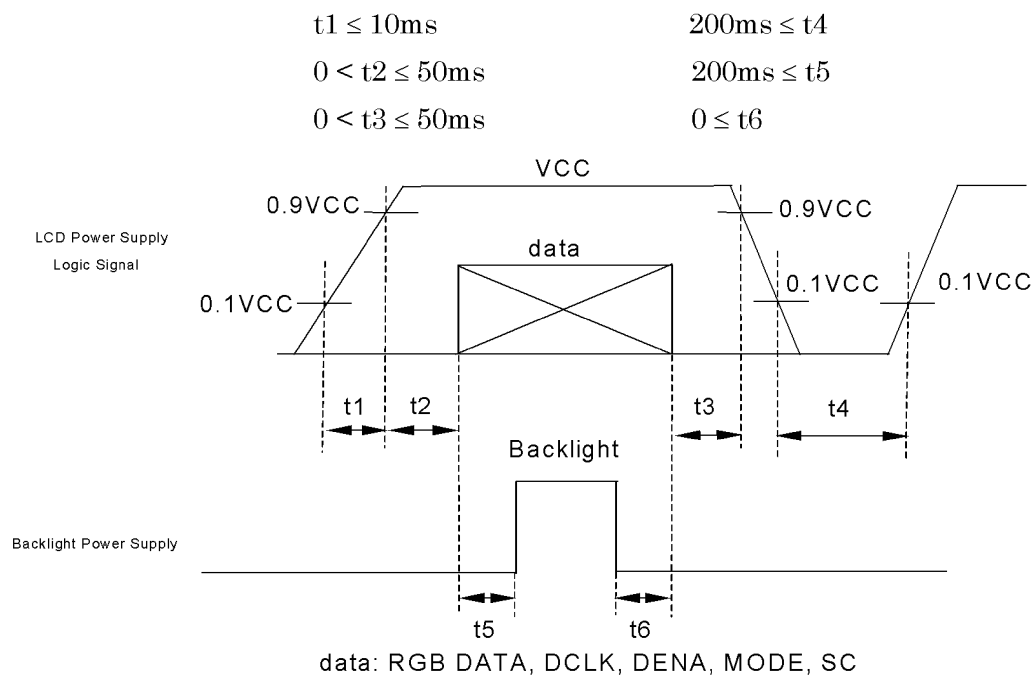

VCC-dip conditions:

- 1) When $2.6\text{ V} \leq VCC < 3.0\text{ V}$, $t_d \leq 10\text{ ms}$
- 2) When $VCC < 2.6\text{ V}$

VCC-dip conditions should also follow the power and signals sequence.

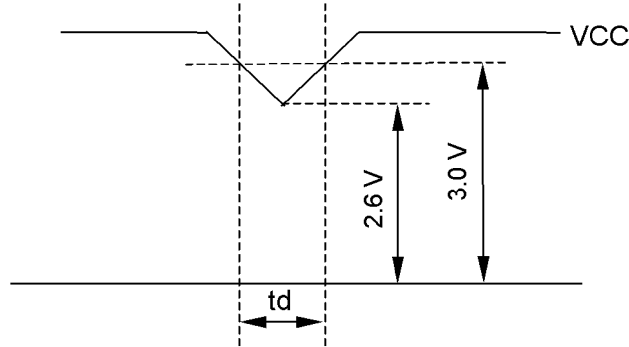

*2) Typical current condition:

64-gray-bar pattern(6 bit)

256-gray-bar pattern(8 bit)

768 line mode

$VCC = +3.3\text{ V}$, $f_H = 48.4\text{ kHz}$, $f_V = 60\text{ Hz}$, $f_{CLK} = 65\text{ MHz}$

(2) Backlight

$T_a = 25^\circ\text{C}$

ITEM	SYMBOL	MIN.	TYP.	MAX.	UNIT	Remarks
Lamp Voltage	VL	--	470	--	Vrms	$IL = 12.0\text{ mArms}$
Lamp Current	IL	6.0	12.0	14.0	mArms	*2), *6)
Lamp Frequency	FL	40	--	100	kHz	*3)
Starting Lamp Voltage	VS	900	--	--	Vrms	$T_a = 25^\circ\text{C}$
		1350	--	--		$T_a = 0^\circ\text{C}$
		1440	--	--		$T_a = -20^\circ\text{C}$
Lamp Life Time	LT	50,000	--	--	h	*4), *5) $IL = 12.0\text{ mArms}$, Continuous operation

[Note]

*1) Please use synchronous inverter.

*2) Lamp Current measurement method (The current meter is inserted in low voltage line.)

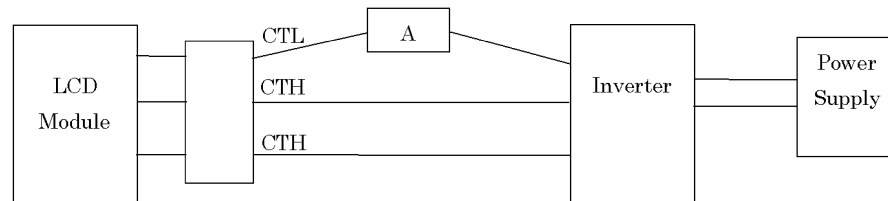

*3) Lamp frequency of inverter may produce interference with horizontal synchronous frequency, and this may cause horizontal beat on the display. Therefore, please adjust lamp frequency, and keep inverter as far from module as possible or use electronic shielding between inverter and module to avoid the interference.

*4) Lamp life time is defined as the time either when the brightness becomes 50% of the initial value, or when the starting lamp voltage does not meet the value specified in this table.

*5) The life time of the backlight depends on the ambient temperature. The life time will decrease under low/high temperature.

*6) Please use the inverter which has symmetrical current wave form as follows,

The degree of unbalance: less than 10%

The ratio of wave height: less than $\sqrt{2} \pm 10\%$

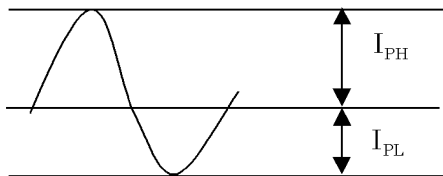

I_{PH} : High side peak

I_{PL} : Low side peak

<p>The degree of unbalance = $I_{PH} - I_{PL} / I_{rms} \times 100(\%)$ The ratio of wave height = $I_{PH}(\text{or } I_{PL}) / I_{rms}$</p>

CURRENT WAVE FORM

5. INTERFACE PIN CONNECTION

(1) CN 1 (Interface Signal)

Used connector: FI-SE20P-HFE (JAE)

Corresponding connector: FI-S20S[for discrete wire] , FI-SE20ME[for FPC] (JAE)

Pin No.	Symbol	Function (ISP 6 bit compatibility mode)		Function (ISP 8 bit compatibility mode)
		6 bit input	8 bit input	
1	VCC	+3.3 V Power supply		←
2	VCC	+3.3 V Power supply		←
3	GND	GND		←
4	GND	GND		←
5	Link 0-	R0, R1, R2, R3, R4, R5, G0	R2, R3, R4, R5, R6, R7, G2	R0, R1, R2, R3, R4, R5, G0
6	Link 0+	R0, R1, R2, R3, R4, R5, G0	R2, R3, R4, R5, R6, R7, G2	R0, R1, R2, R3, R4, R5, G0
7	GND	GND		←
8	Link 1-	G1, G2, G3, G4, G5, B0, B1	G3, G4, G5, G6, G7, B2, B3	G1, G2, G3, G4, G5, B0, B1
9	Link 1+	G1, G2, G3, G4, G5, B0, B1	G3, G4, G5, G6, G7, B2, B3	G1, G2, G3, G4, G5, B0, B1
10	GND	GND		←
11	Link 2-	B2, B3, B4, B5, DENA	B4, B5, B6, B7, DENA	B2, B3, B4, B5, DENA
12	Link 2+	B2, B3, B4, B5, DENA	B4, B5, B6, B7, DENA	B2, B3, B4, B5, DENA
13	GND	GND		←
14	CLKIN-	Clock -		←
15	CLKIN+	Clock +		←
16	GND	GND		←
17	Link3-	See: *2)	R0, R1, G0, G1, B0, B1	R6, R7, G6, G7, B6, B7
18	Link3+	See: *2)	R0, R1, G0, G1, B0, B1	R6, R7, G6, G7, B6, B7
19	MODE	Low=ISP 6 bit compatibility mode		High=ISP 8 bit compatibility mode
20	SC	Scan direction control. (Low : Normal , High : Reverse)		←

*1) The shielding case is connected with GND.

*2) Recommended wiring of Pin 17,18 (6 bit input)

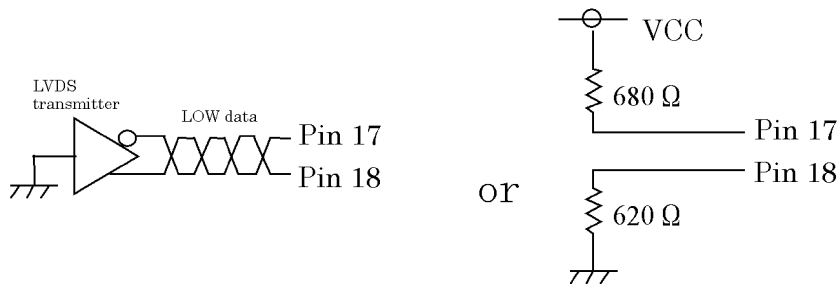

(2) CN 2 (Backlight)

Backlight-side connector: BHR-04VS-1 (JST)

Inverter-side connector: SM04(4.0)B-BHS(LF)(SN) (JST)

Pin No.	Symbol	Function
1, 2	CTH	VBLH (High voltage)
4	CTL	VBLL (Low voltage)

[Note] VBLH · VBLL = VL

(3) ISP data mapping

a. ISP 6 bit compatibility mode(6 bit input)

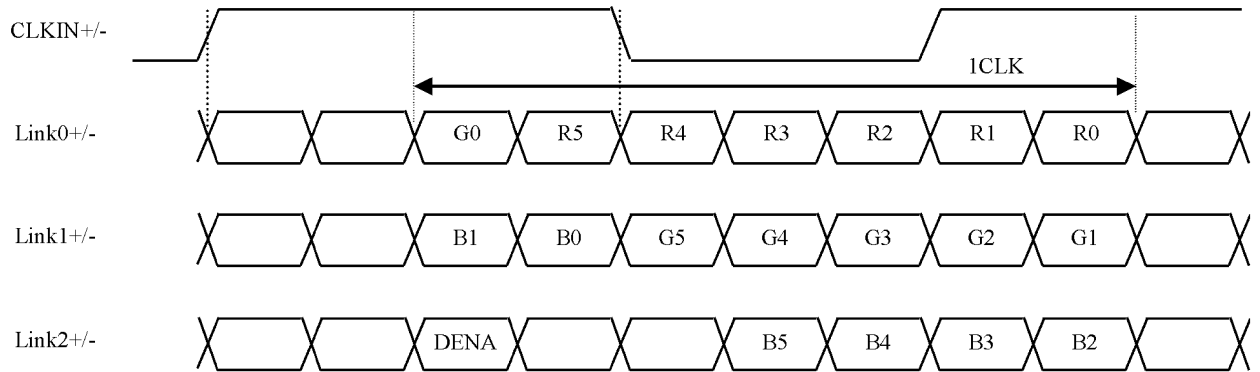

b. ISP 6 bit compatibility mode(8 bit input)

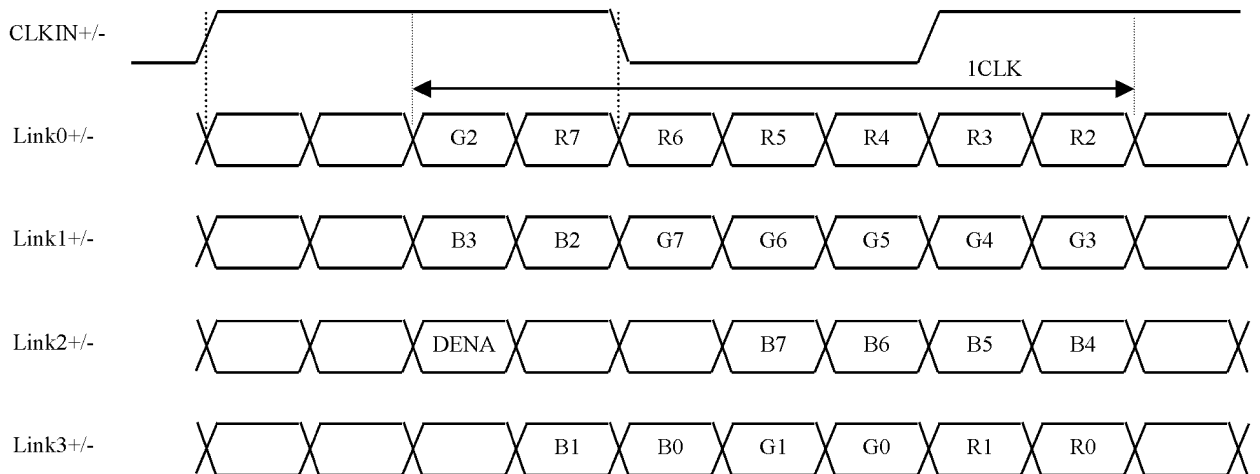

c. ISP 8 bit compatibility mode

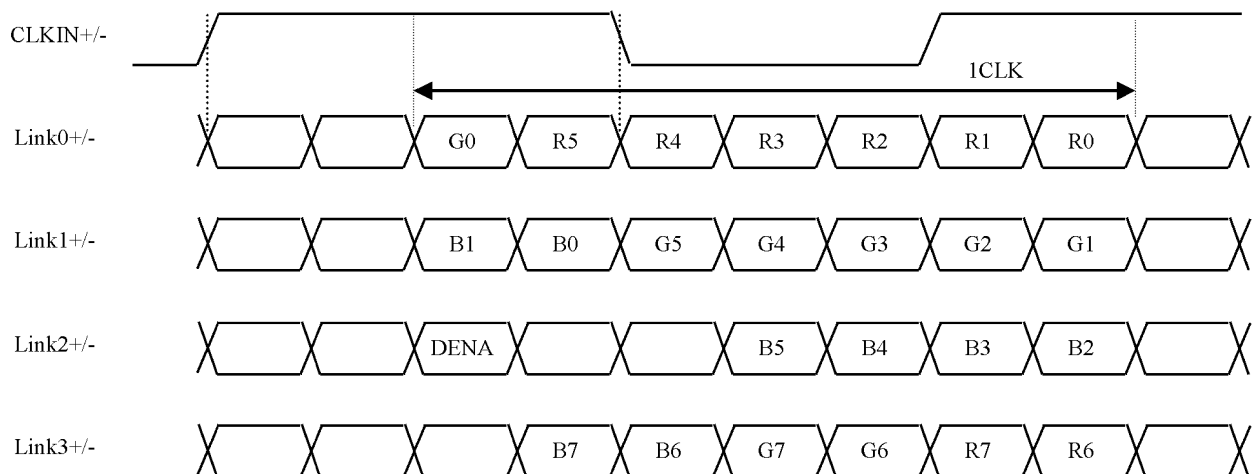

6. INTERFACE TIMING

LVDS transmitter input signal

(1) Timing Specifications

ITEM		SYMBOL	MIN.	TYP.	MAX.	UNIT	
DCLK	Frequency	f _{CLK}	50	65	80	MHz	
	Period	t _{CLK}	12.5	15.4	20	ns	
DENA	Horizontal	Active Time	t _{HA}	1024	1024	1024	t _{CLK}
		Blanking Time	t _{HB}	20	320	511	t _{CLK}
		Frequency	f _H	42.4	48.4	60	kHz
		Period	t _H	16.6	20.7	23.6	μs
	Vertical	Active Time	t _{VA}	768	768	768	t _H
		Blanking Time	t _{VB}	3	38	--	t _H
		Frequency	f _V	55	60	75	Hz
		Period	t _V	13.3	16.7	18.2	ms

[Note]

- 1) DENA (Data Enable) should always be positive polarity as shown in the timing specification.
- 2) DCLK should appear during all invalid period.
- 3) LVDS timing follows the timing specifications of LVDS receiver IC:

THC63LVDF84B(Thine).

- 4) In case of blanking time fluctuation, please use following.

$$t_{VBn} > t_{VBn-1} - 3(t_H)$$

(2) Timing Chart

a. Horizontal Timing Chart

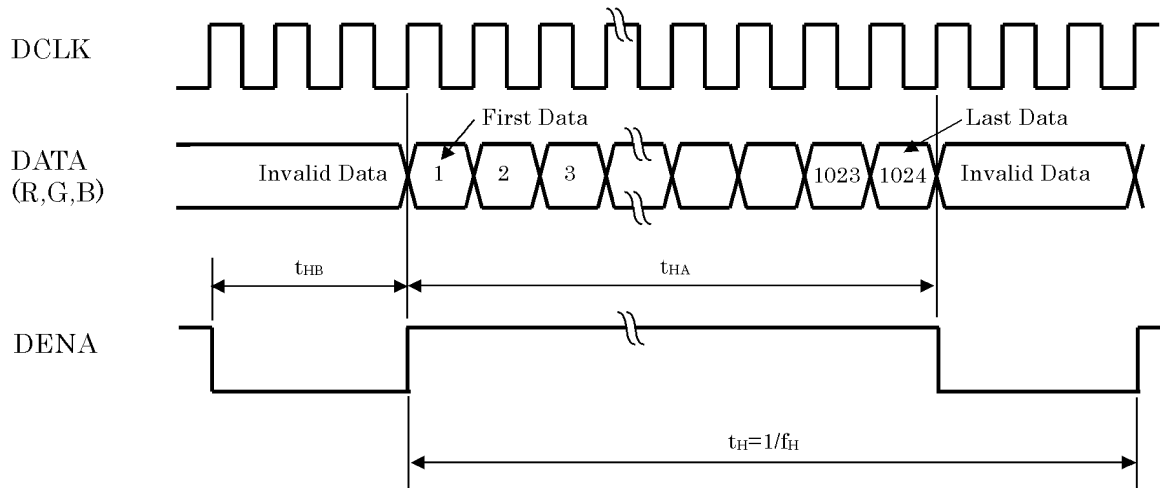

b. Vertical Timing Chart

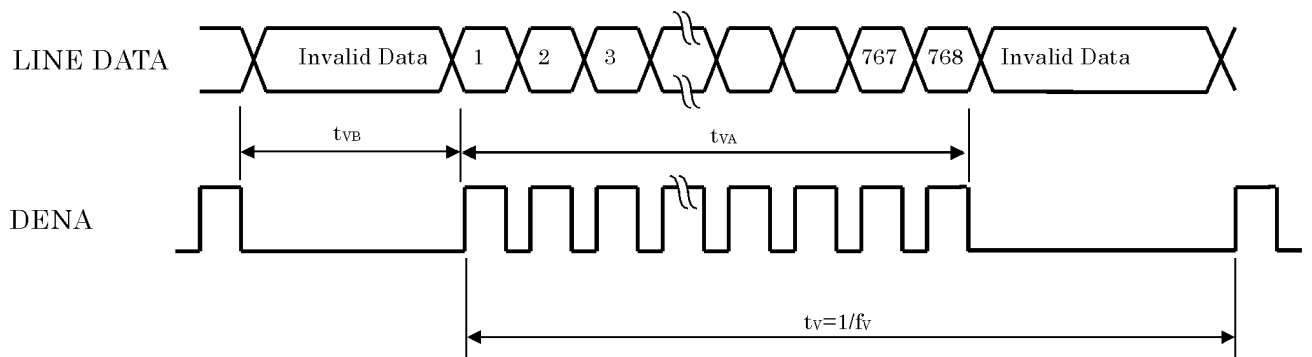

(3) Color Data Assignment

a. 6 bit input

COLOR		INPUT DATA																	
		R DATA						G DATA						B DATA					
		R5	R4	R3	R2	R1	R0	G5	G4	G3	G2	G1	G0	B5	B4	B3	B2	B1	B0
		MSB					LSB	MSB					LSB	MSB					LSB
BASIC COLOR	BLACK	0	0	0	0	0	0	0	0	0	0	0	0	0	0	0	0	0	0
	RED(63)	1	1	1	1	1	1	0	0	0	0	0	0	0	0	0	0	0	0
	GREEN(63)	0	0	0	0	0	0	1	1	1	1	1	1	0	0	0	0	0	0
	BLUE(63)	0	0	0	0	0	0	0	0	0	0	0	0	1	1	1	1	1	1
	CYAN	0	0	0	0	0	0	1	1	1	1	1	1	1	1	1	1	1	1
	MAGENTA	1	1	1	1	1	1	0	0	0	0	0	0	1	1	1	1	1	1
	YELLOW	1	1	1	1	1	1	1	1	1	1	1	1	0	0	0	0	0	0
	WHITE	1	1	1	1	1	1	1	1	1	1	1	1	1	1	1	1	1	1
RED	RED(1)	0	0	0	0	0	1	0	0	0	0	0	0	0	0	0	0	0	0
	RED(2)	0	0	0	0	1	0	0	0	0	0	0	0	0	0	0	0	0	0
	RED(62)	1	1	1	1	1	0	0	0	0	0	0	0	0	0	0	0	0	0
	RED(63)	1	1	1	1	1	1	0	0	0	0	0	0	0	0	0	0	0	0
GREEN	GREEN(1)	0	0	0	0	0	0	0	0	0	0	0	1	0	0	0	0	0	0
	GREEN(2)	0	0	0	0	0	0	0	0	0	0	1	0	0	0	0	0	0	0
	GREEN(62)	0	0	0	0	0	0	1	1	1	1	1	0	0	0	0	0	0	0
GREEN(63)	0	0	0	0	0	0	1	1	1	1	1	1	0	0	0	0	0	0	
BLUE	BLUE(1)	0	0	0	0	0	0	0	0	0	0	0	0	0	0	0	0	0	1
	BLUE(2)	0	0	0	0	0	0	0	0	0	0	0	0	0	0	0	0	1	0
	BLUE(62)	0	0	0	0	0	0	0	0	0	0	0	0	1	1	1	1	1	0
	BLUE(63)	0	0	0	0	0	0	0	0	0	0	0	0	1	1	1	1	1	1

[Note]

1) Definition of gray scale

Color (n) --- n indicates gray scale level.

Higher n means brighter level.

2) Data

1:High, 0: Low

b. 8 bit input

COLOR		INPUT DATA																																	
		R DATA								G DATA								B DATA																	
		R7	R6	R5	R4	R3	R2	R1	R0	G7	G6	G5	G4	G3	G2	G1	G0	B7	B6	B5	B4	B3	B2	B1	B0										
		MSB								LSB				MSB								LSB				MSB								LSB	
BASIC COLOR	BLACK	0	0	0	0	0	0	0	0	0	0	0	0	0	0	0	0	0	0	0	0	0	0	0	0										
	RED(255)	1	1	1	1	1	1	1	1	0	0	0	0	0	0	0	0	0	0	0	0	0	0	0	0										
	GREEN(255)	0	0	0	0	0	0	0	0	1	1	1	1	1	1	1	1	0	0	0	0	0	0	0	0										
	BLUE(255)	0	0	0	0	0	0	0	0	0	0	0	0	0	0	0	0	1	1	1	1	1	1	1	1										
	CYAN	0	0	0	0	0	0	0	0	1	1	1	1	1	1	1	1	1	1	1	1	1	1	1	1										
	MAGENTA	1	1	1	1	1	1	1	1	0	0	0	0	0	0	0	0	1	1	1	1	1	1	1	1										
	YELLOW	1	1	1	1	1	1	1	1	1	1	1	1	1	1	1	1	0	0	0	0	0	0	0	0										
	WHITE	1	1	1	1	1	1	1	1	1	1	1	1	1	1	1	1	1	1	1	1	1	1	1	1										
RED	RED(1)	0	0	0	0	0	0	0	1	0	0	0	0	0	0	0	0	0	0	0	0	0	0	0	0										
	RED(2)	0	0	0	0	0	0	1	0	0	0	0	0	0	0	0	0	0	0	0	0	0	0	0	0										
	RED(255)	1	1	1	1	1	1	1	1	0	0	0	0	0	0	0	0	0	0	0	0	0	0	0	0										
GREEN	GREEN(1)	0	0	0	0	0	0	0	0	0	0	0	0	0	0	0	1	0	0	0	0	0	0	0	0										
	GREEN(2)	0	0	0	0	0	0	0	0	0	0	0	0	0	0	1	0	0	0	0	0	0	0	0	0										
	GREEN(255)	0	0	0	0	0	0	0	0	1	1	1	1	1	1	1	1	0	0	0	0	0	0	0	0										
BLUE	BLUE(1)	0	0	0	0	0	0	0	0	0	0	0	0	0	0	0	0	0	0	0	0	0	0	0	1										
	BLUE(2)	0	0	0	0	0	0	0	0	0	0	0	0	0	0	0	0	0	0	0	0	0	0	1	0										
	BLUE(255)	0	0	0	0	0	0	0	0	0	0	0	0	0	0	0	0	1	1	1	1	1	1	1	1										

[Note]

1) Definition of gray scale

Color (n) --- n indicates gray scale level.

Higher n means brighter level.

2) Data

1:High, 0: Low

(4) Display Position and Scan Direction

D(X,Y) shows the data number of input signal for LCD panel signal processing PCB.

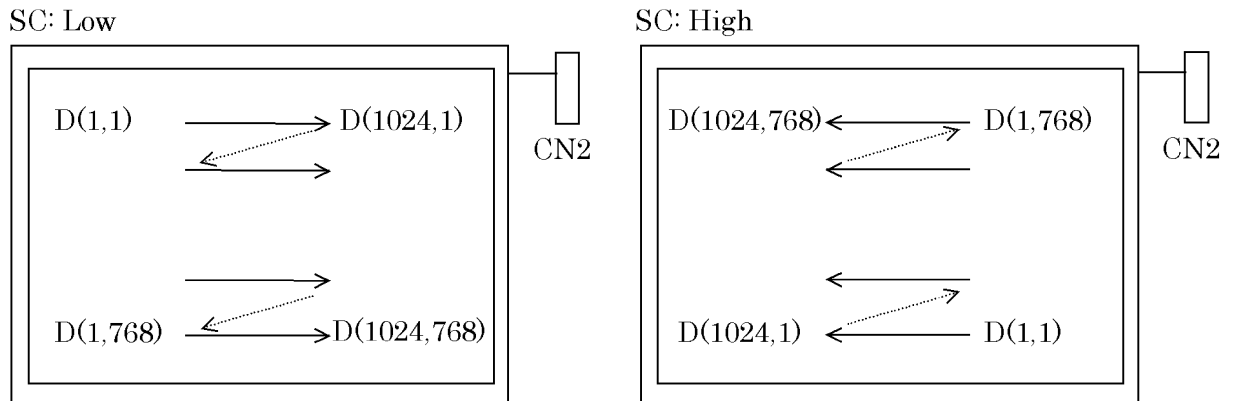

7. BLOCK DIAGRAM

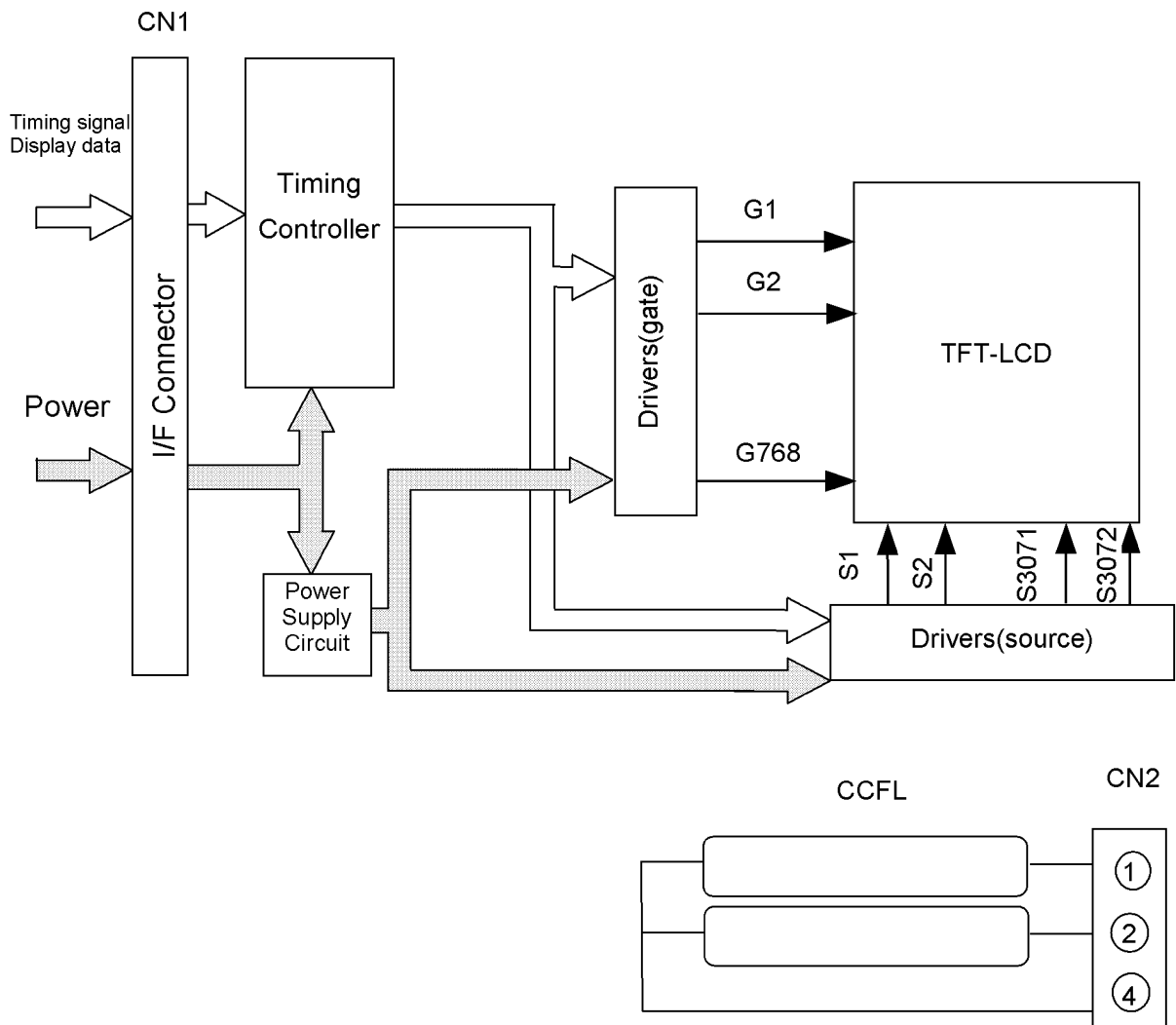

8. MECHANICAL SPECIFICATIONS

(1) Front Side

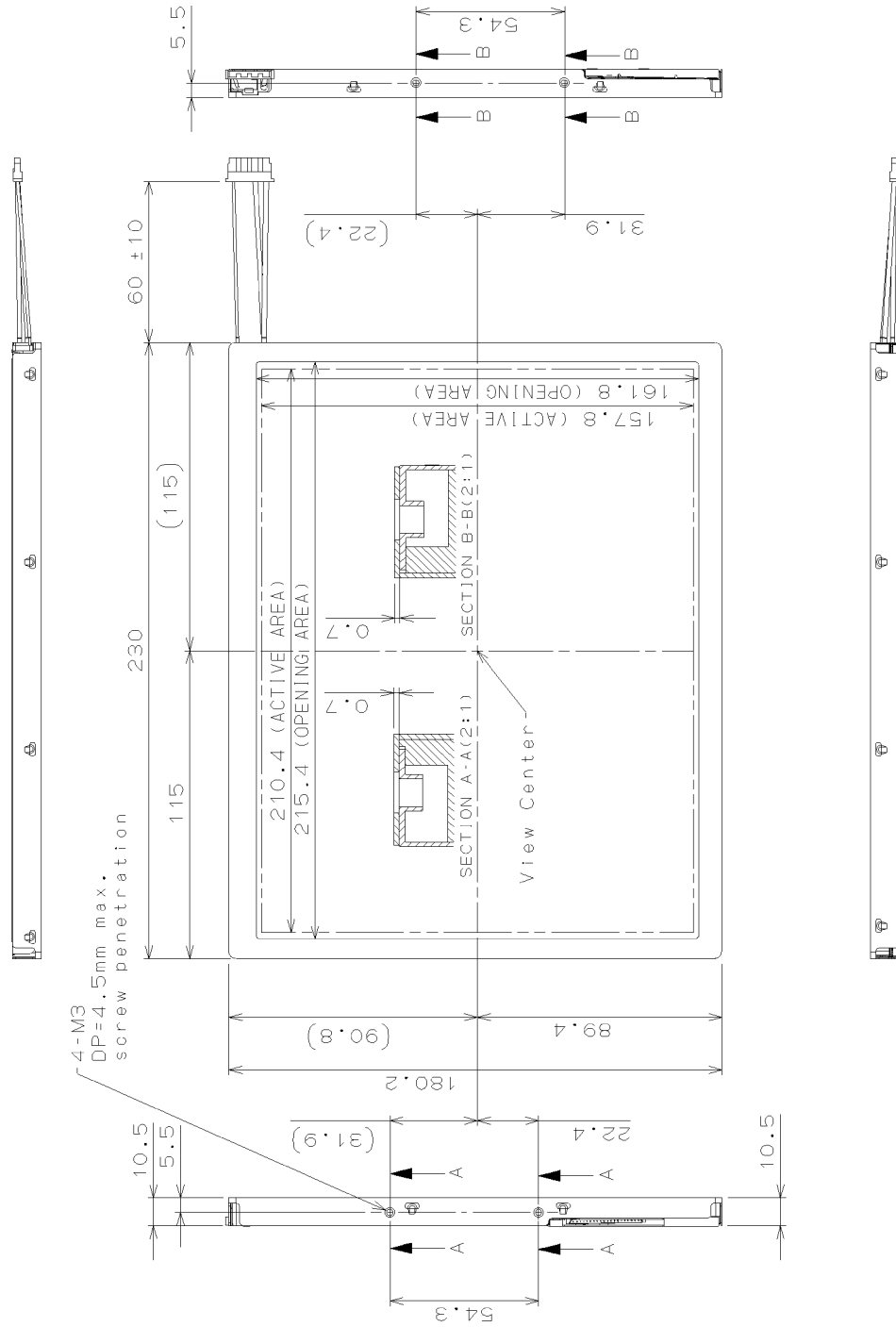

1) Tolerance is ±0.5mm unless noted

(Unit:mm)

(2) Rear Side

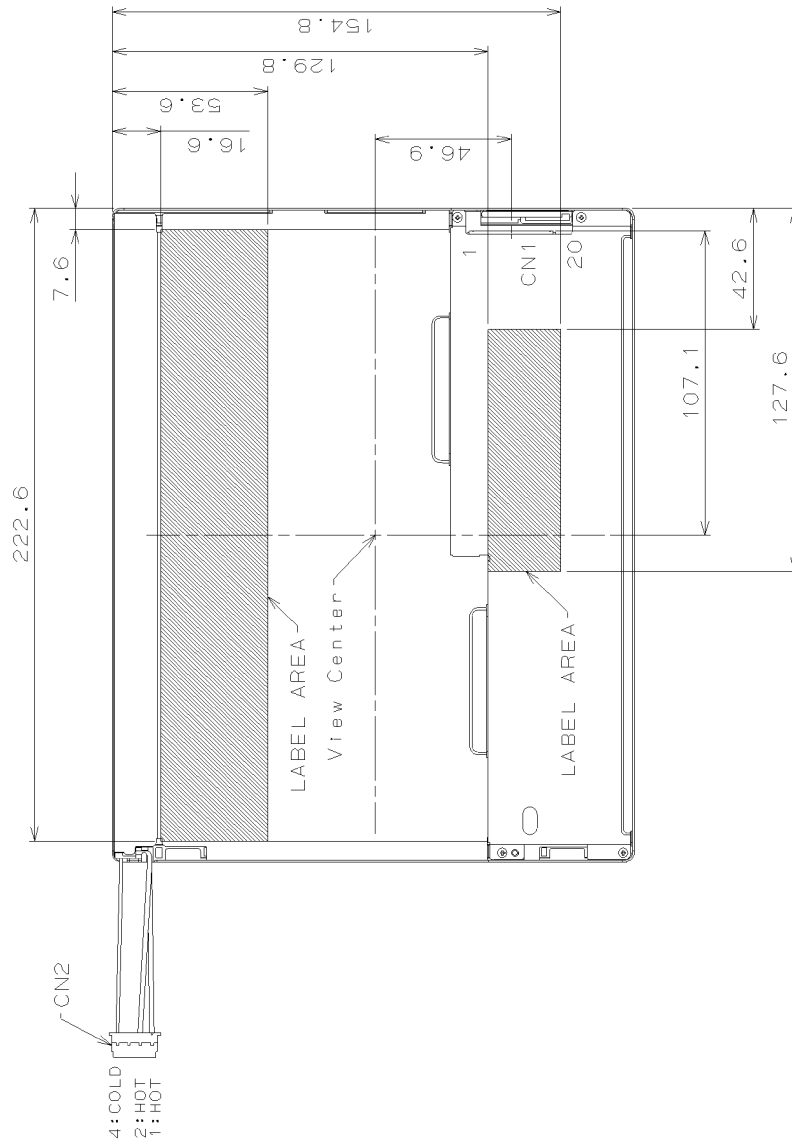

1) Tolerance is ± 0.5 mm unless noted

CN1: FJ-SE20P-HFE (JAE)
CN2: BHR-04VS-1 (JST)

(Unit:mm)

9. OPTICAL CHARACTERISTICS

Ta=25°C, VCC=3.3V, Input Signals: Typ. Values shown in Section 6

ITEM	SYMBOL	CONDITION	MIN	TYP	MAX	UNIT	Remarks	
Contrast Ratio	CR	$\theta_V=0^\circ, \theta_H=0^\circ$	390	600	--	--	*1)*2)*5)	
Luminance	Lw	$\theta_V=0^\circ, \theta_H=0^\circ$	320	400	--	cd/m ²	*3)*5)	
Luminance Uniformity	ΔLw	$\theta_V=0^\circ, \theta_H=0^\circ$	--	--	30	%	*1)*3)*5)	
Response Time	tr	$\theta_V=0^\circ, \theta_H=0^\circ$	--	4	--	ms	*1)*4)*5)	
	tf	$\theta_V=0^\circ, \theta_H=0^\circ$	--	12	--	ms	*1)*4)*5)	
Viewing Angle	Horizontal	θ_H	$CR \geq 10$	-70~70	-80~80	--	°	*1)*5)
	Vertical	θ_V		-55~55	-65~65	--	°	*1)*5)
	Horizontal	θ_H	$CR \geq 5$	-70~70	-80~80	--	°	*1)*5)
	Vertical	θ_V		-70~70	-80~80	--	°	*1)*5)
Image sticking	tis	2 h	--	--	2	s	*6)	
Color Coordinates	Red	Rx	$\theta_V=0^\circ, \theta_H=0^\circ$	0.540	0.570	0.600	--	*1)*5)
		Ry		0.302	0.332	0.362		
	Green	Gx		0.292	0.322	0.352		
		Gy		0.501	0.531	0.561		
	Blue	Bx		0.127	0.157	0.187		
		By		0.117	0.147	0.177		
	White	Wx		0.283	0.313	0.343		
		Wy		0.299	0.329	0.359		

[Note]

These items are measured using CS1000(MINOLTA) for color coordinates, EZContrast(ELDIM) for viewing angle and CS1000 or BM-5A(TOPCON) for others under the dark room condition (no ambient light) after more than 30 minutes from turning on the lamp unless noted.

Condition: IL = 12.0 mArms, FL = 55 kHz

Measurement method for luminance and color coordinates is as follows.

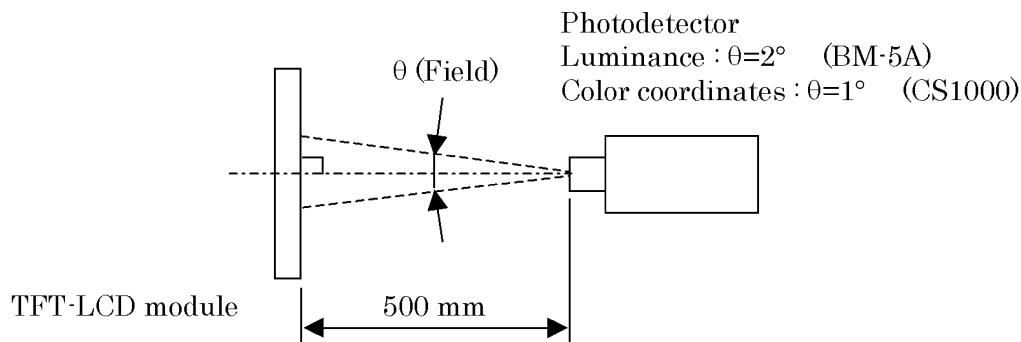

The luminance is measured according to FLAT PANEL DISPLAY MEASUREMENTS STANDARD (VESA Standard).

*1) Measurement Point

Contrast Ratio, Luminance, Response Time, Viewing Angle, Color Coordinates: Display Center

Luminance Uniformity: point 1~5 shown in a figure below

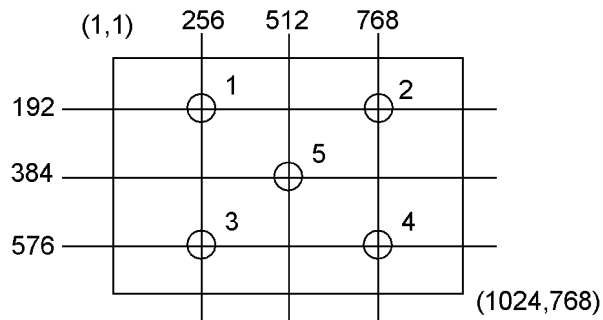

*2) Definition of Contrast Ratio

CR= Luminance with all white pixels / Luminance with all black pixels

*3) Definition of Luminance Uniformity

$$\Delta L_w = [L_w(\text{MAX})/L_w(\text{MIN}) - 1] \times 100$$

*4) Definition of Response Time

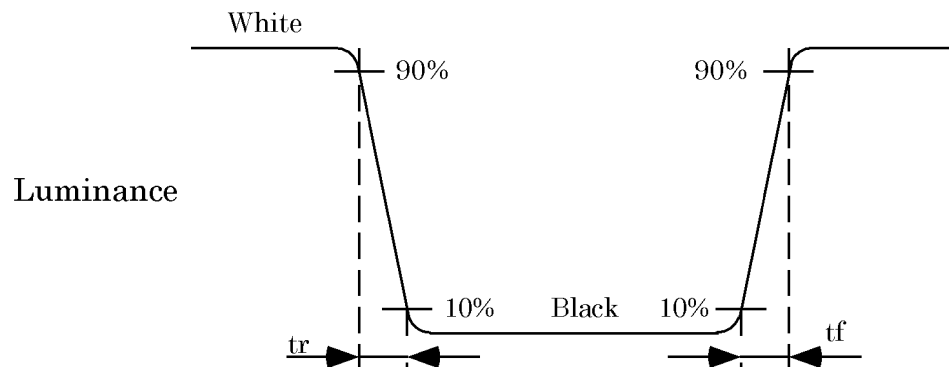

*5) Definition of Viewing Angle (θ_v , θ_H)

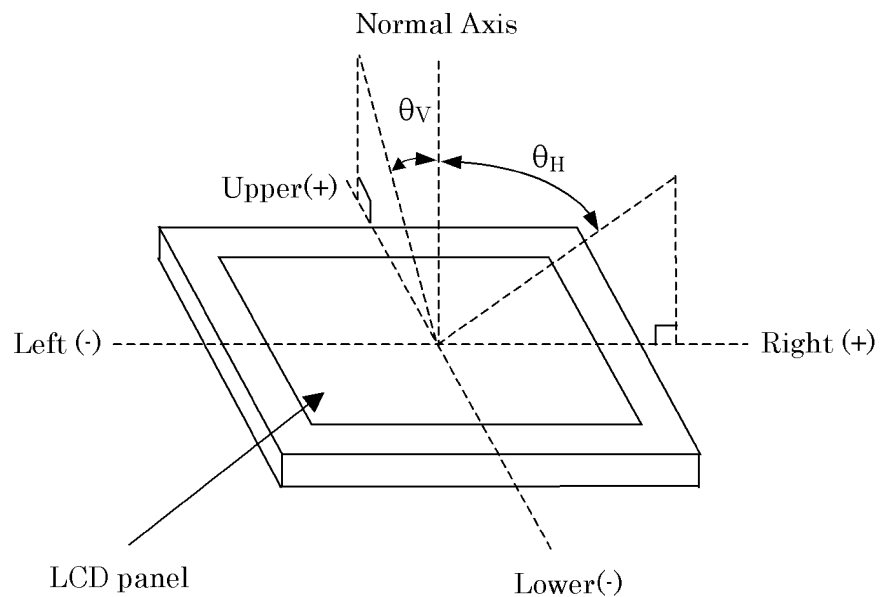

*6) Image sticking:

Continuously display the test pattern shown in the figure below for two-hours. Then display a completely white screen. The previous image shall not persist more than two seconds at 25°C.

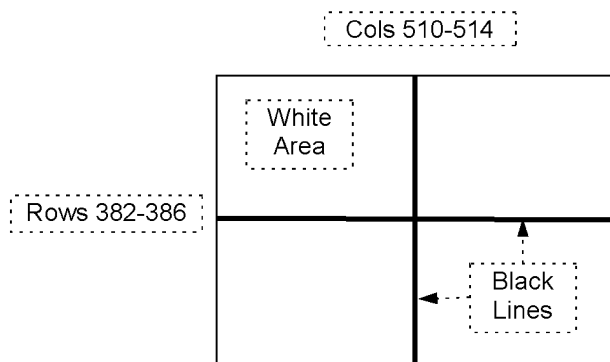

TEST PATTERN FOR IMAGE STICKING TEST

10. RELIABILITY TEST CONDITION

(1) Temperature and Humidity

TEST ITEM	CONDITIONS
HIGH TEMPERATURE HIGH HUMIDITY OPERATION	40°C, 90%RH, 240 h (No condensation)
HIGH TEMPERATURE OPERATION	70°C, 240 h
LOW TEMPERATURE OPERATION	-20°C, 240 h
HIGH TEMPERATURE STORAGE	80°C, 240 h
LOW TEMPERATURE STORAGE	-20°C, 240 h
THERMAL SHOCK	BETWEEN -20°C (1h) and 80°C(1h), 100 CYCLES

(2) Shock & Vibration

ITEM	CONDITIONS
SHOCK (NON-OPERATION)	Shock level: 1470m/s ² (150G) Waveform: half sinusoidal wave, 2ms Number of shocks: one shock input in each direction of three mutually perpendicular axes for a total of six shock inputs
VIBRATION (NON-OPERATION)	Vibration level: 9.8m/s ² (1.0G) Waveform: sinusoidal Frequency range: 5 to 500Hz Frequency sweep rate: 0.5 octave /min Duration: one sweep from 5 to 500 Hz in each of three mutually perpendicular axis(each x,y,z axis: 1 hour, total 3 hours)

(3) Judgment standard

The judgment of the above tests should be made as follow:

Pass: Normal display image, no damage of the display function. (ex. no line defect)

Partial transformation of the module parts should be ignored.

Fail: No display image, damage of the display function. (ex. line defect)